

# DZ63374-4 Accuride Teleskopschiene

## Gehäusemontagewinkel, typische Anwendungen: DZ2907

Brackets  
Équerres  
Winkel

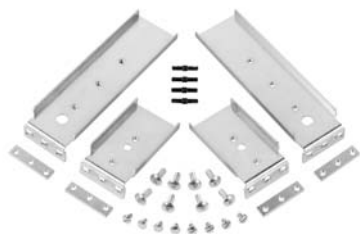

DZ63374-4  
(2907)



DZ63460-4  
(0201, 0204, 0301, 0305)



DZ63480-4  
(3301, 3307, 3308)



DZ63450-4  
(0201, 0204, 0301, 0305)



DZ65490-4  
(3607, 5321, 5321SC)

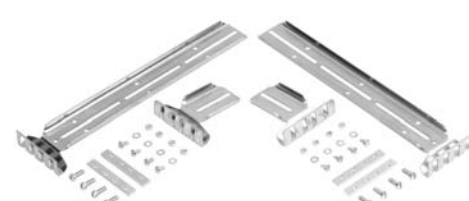

DZ63470-4  
(0305\*)

63xxx	mm											
	SL	A (F)	A (R)	B (4)	B (3)	C	D	E	G	H	J	K
DZ63450-4	0201, 0204, 0301, 0305	69.9	266.7	57.2	-	15.0	6.35	12.7	-	76.2	82.6	165.1
DZ63460-4	0201, 0204, 0301, 0305	69.9	266.7	-	43.7	15.0	6.5	15.9	-	76.2	82.6	165.1
DZ63470-4	0305*	76.5	274.6	69.9(F) 64.0(R)	-	19.8	5.5(F) 7.4(R)	15.9	48.0	76.2	82.6	165.1
DZ63480-4	3301, 3307, 3308	114.6	114.6	-	44.5	18.3	7.4	15.2	66.0	-	-	-
DZ65490-4	3607, 5321, 5321SC	140.0	140.0	60.0	-	14.0	5.5	15.9	96.0	-	-	-
DZ63374-4	2907	77.2	153.4	-	44.2	17.5	-	15.9	-	-	-	-

\* Recessed

(F) Front

(R) Rear

(4) 4 hole

(3) 3 hole

\* Montage en retrait

(F) Avant

(R) Arrière

(4) 4 trous

(3) 3 trous

\* Versetzt Montiert

(F) Vorne

(R) Hinten

(4) 4-Loch

(3) 3-Loch

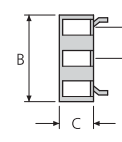
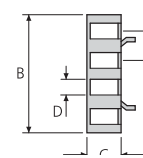
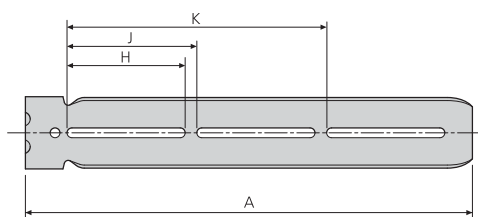
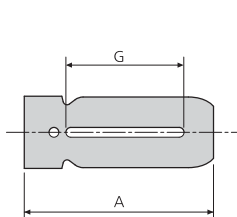

Bar nuts  
Barre taraudée  
Leistenmuttern

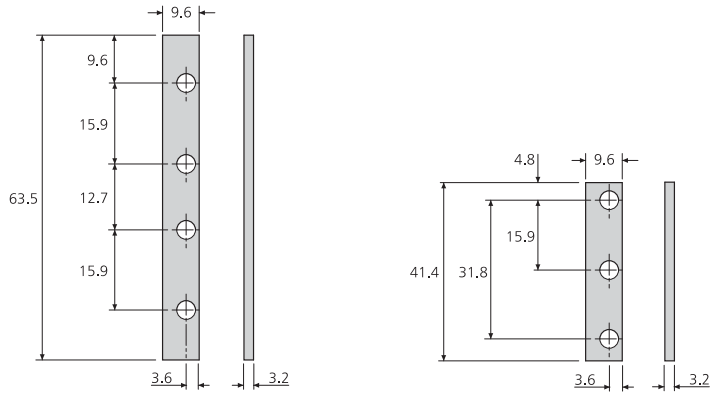

**Notes:**

- Each kit comprises 4 brackets, 4 bar nuts, 8 screw kits for brackets, 8 fillister head screws. Customer supplies captive nuts.

**Notes:**

- Chaque kit comprend 4 équerres de fixation, 4 barres taraudées, 8 boulons de fixation, 8 vis de fixation à tête cylindrique fendue. Les écrous cages ne sont pas fournis.

**Hinweise:**

- Jeder Satz enthält 4 Winkel, 4 Leistenmuttern, 8 Schrauben für Winkel, 8 Linsenkopfschrauben. Unverlierbare Muttern sind vom Verarbeiter zu stellen.