

Artikelbeschreibung/Produktabbildungen



**Beschreibung**

**Werkstoff:**

Hülse 1.4305.  
Druckbolzen 1.4034.  
Feder 1.4310.

**Ausführung:**

blank. Druckbolzen gehärtet.



Zeichnungen

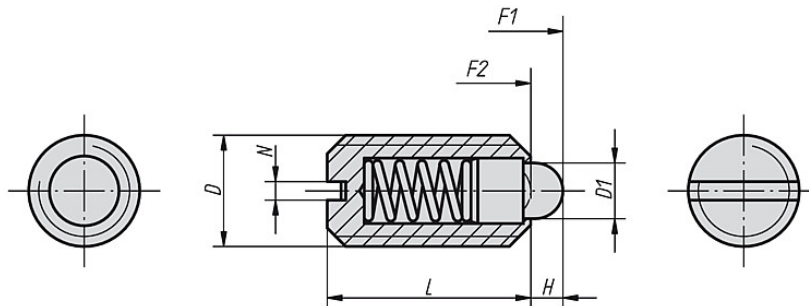

Artikelübersicht

Bestellnummer	Material	D	D1	L	H	N	Federkraft Anfang F1 ca. N	Federkraft Ende F2 ca. N	Gewicht ca. g
K0314.04	Edelstahl	M4	1,8	9	1,5	0,6	6	20	0,39
K0314.05	Edelstahl	M5	2,4	12	2	0,8	6	20	1
K0314.06	Edelstahl	M6	2,7	14	2	1	7	20	1,7
K0314.08	Edelstahl	M8	4	16	2	1,2	15	30	4
K0314.10	Edelstahl	M10	4,5	19	2,5	1,6	20	35	7
K0314.12	Edelstahl	M12	6	22	3,5	2	30	55	13
K0314.16	Edelstahl	M16	8,5	24	4,5	2,5	45	100	24
K0314.20	Edelstahl	M20	10	30	6,5	2,5	60	120	46,3

