























Ausführung P800 - Stellfuß mit Bodenverankerung. Schwenkbarer Gewindestift mit Sicherungssechskantmutter

	Art.	D	H	I	H1	h	A	s	d2	d3	C	d1	Q	 g	F1 (N)
	P800080.TM12X..01	80	20	54	28	16	20	8	9	M08	10	M12	50-70-90-110-130-150-170-190	*	13000
	P800080.TM14X..01	80	20	54	28	16	20	8	9	M08	12	M14	50-70-90-110-130-150-170-190	*	13000
	P800080.TM16X..01	80	20	54	28	16	20	8	9	M08	13	M16	50-70-90-110-130-150-170-190	*	13000
	P800080.TM20X..01	80	20	54	28	16	20	8	9	M08	19	M20	50-70-90-110-130-150-170-190	*	13000
	P800105.TM12X..01	105	22	74	30	18,5	21	8	11	M10	10	M12	50-70-90-110-130-150-170-190	*	15000
	P800105.TM14X..01	105	22	74	30	18,5	21	8	11	M10	12	M14	50-70-90-110-130-150-170-190	*	15000
	P800105.TM16X..01	105	22	74	30	18,5	21	8	11	M10	13	M16	50-70-90-110-130-150-170-190	*	15000
	P800105.TM20X..01	105	22	74	30	18,5	21	8	11	M10	17	M20	50-70-90-110-130-150-170-190	*	15000
	P800105.TM24X..01	105	22	74	30	18,5	21	8	11	M10	19	M24	50-70-90-110-130-150-170-190	*	15000
	P800105.TM30X..01	105	22	74	30	18,5	21	8	11	M10	24	M30	50-70-90-110-130-150-170-190	*	15000
	P800130.TM16X..01	130	24	99	32	20	21	8	13	M10	13	M16	50-70-90-110-130-150-170-190	*	17000
	P800130.TM20X..01	130	24	99	32	20	21	8	13	M10	17	M20	50-70-90-110-130-150-170-190	*	17000
	P800130.TM24X..01	130	24	99	32	20	21	8	13	M10	19	M24	50-70-90-110-130-150-170-190	*	17000
	P800130.TM30X..01	130	24	99	32	20	21	8	13	M10	24	M30	50-70-90-110-130-150-170-190	*	17000

Die Stifflänge bei den Auslassungspunkten einfügen.

*Siehe Tabelle auf Seite 24

Ausführung P801 - Stellfuß mit Bodenverankerung. Schwenkbarer Gewindestift mit Seeger-Klemmringfixierung

	Art.	D	H	I	H1	h	A	s	d2	d3	C	d1	Q	 g	F1 (N)
	P801080.TM12X..01	80	20	54	28	16	20	8	9	8	10	M12	50-70-90-110-130-150-170-190	*	13000
	P801080.TM14X..01	80	20	54	28	16	20	8	9	8	12	M14	50-70-90-110-130-150-170-190	*	13000
	P801080.TM16X..01	80	20	54	28	16	20	8	9	8	13	M16	50-70-90-110-130-150-170-190	*	13000
	P801080.TM20X..01	80	20	54	28	16	20	8	9	8	19	M20	50-70-90-110-130-150-170-190	*	13000
	P801105.TM12X..01	105	22	74	30	18,5	21	8	11	10	10	M12	50-70-90-110-130-150-170-190	*	15000
	P801105.TM14X..01	105	22	74	30	18,5	21	8	11	10	12	M14	50-70-90-110-130-150-170-190	*	15000
	P801105.TM16X..01	105	22	74	30	18,5	21	8	11	10	13	M16	50-70-90-110-130-150-170-190	*	15000
	P801105.TM20X..01	105	22	74	30	18,5	21	8	11	10	17	M20	50-70-90-110-130-150-170-190	*	15000
	P801105.TM24X..01	105	22	74	30	18,5	21	8	11	10	19	M24	50-70-90-110-130-150-170-190	*	15000
	P801105.TM30X..01	105	22	74	30	18,5	21	8	11	10	24	M30	50-70-90-110-130-150-170-190	*	15000
	P801130.TM16X..01	130	24	99	32	20	21	8	13	10	13	M16	50-70-90-110-130-150-170-190	*	17000
	P801130.TM20X..01	130	24	99	32	20	21	8	13	10	17	M20	50-70-90-110-130-150-170-190	*	17000
	P801130.TM24X..01	130	24	99	32	20	21	8	13	10	19	M24	50-70-90-110-130-150-170-190	*	17000
	P801130.TM30X..01	130	24	99	32	20	21	8	13	10	24	M30	50-70-90-110-130-150-170-190	*	17000

Die Stifflänge bei den Auslassungspunkten einfügen.

*Siehe Tabelle auf Seite 24

P800 - P801



Material:
verstärktes Polyamid.
Öl- und fettbeständig.

Oberfläche:
Satinert.

Farben:
Schwarz (RAL 9011).

Einsätze:

Ausführung P800:

- (2) Unterlagscheibe aus verzinktem Stahl.
- (1) Sicherungsmutter aus verzinktem Stahl UNI 7473.
- Gedrehter Gewindestift mit Befestigungsschraube aus verzinktem Stahl.

Version P801:

- (2) Unterlagscheibe aus verzinktem Stahl.
- (1) Seeger-Ring aus Schwarzoxyd-Stahl UNI 7435.
- Gedrehter Gewindestift und Befestigungsendstück mit Seeger-Ringsitz aus verzinktem Stahl.

Bodenverankerung:

Die Füße werden mit geschlossen Löchern für die Bodenverankerung geliefert. Um sie zu öffnen, ist die Plastikmembran zu durchbrechen (siehe Zeichnung).

SONDERAUSFÜHRUNG:

- Auf Anfrage und bei bestimmten Stückzahlen können die Stifte mit den gewünschten Längen geliefert werden.
- Auf Anfrage und bei bestimmten Abnahmemengen ist der Teller in Orange (RAL 2004) lieferbar.

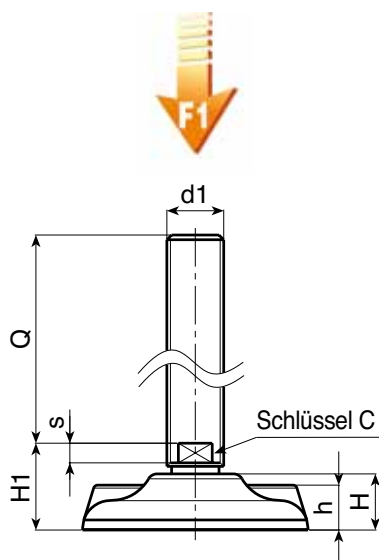

P800

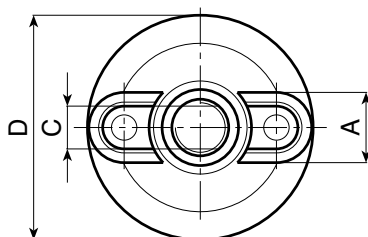
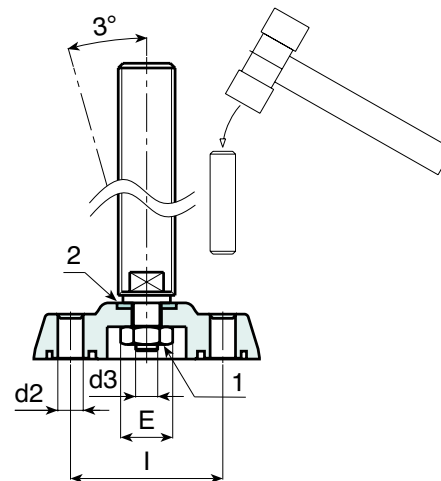

P801

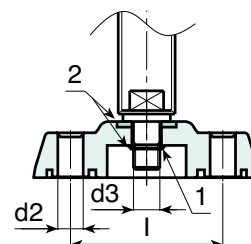

Möglich vorrätiger Warenbestand in %

(☒) 90% (☑) 40% (☒) 5% (☒)

BOTECO® - © All right reserved - www.boteco.it

Any unauthorized reproduction is strictly forbidden



BOTECO