

KOMPETENTE BERATUNG SEIT 1919

# LESCH HORN

NORM INDUSTRIE MESSTECHNIK

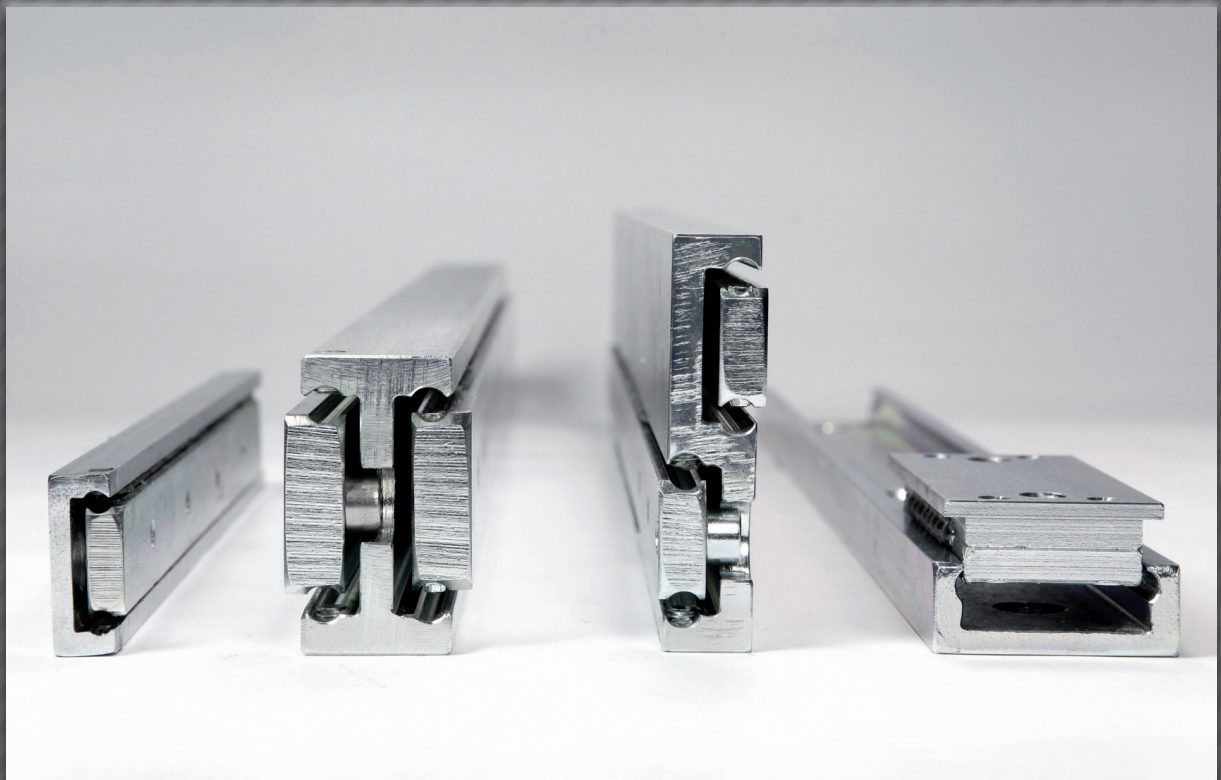

**HEAVY DUTY RAILS**  
EDITION 02/04-2013



About us	2
How to order	6
Outline of rail products	7

---

## Heavy duty rails

Outline	8
Heavy duty rails	10
Types of rails	12
Outline heavy duty rails	14
5321EC load rating up to 100 kg	16
5417 load rating up to 100 kg	17
3607 load rating up to 120 kg	18
5321-60 load rating up to 120 kg	19
DS5322 load rating up to 120 kg	20
5321SC load rating up to 120 kg	21
DA4162 load rating up to 150 kg	22
7957 load rating up to 160 kg	24
5321 load rating up to 170 kg	26
DS5321 load rating up to 180 kg	27
0522 load rating up to 180 kg	28
9301 load rating up to 227 kg	30
9308 load rating up to 227 kg	32
DA4160 load rating up to 300 kg	34
DA4140 load rating up to 400 kg	35
DA4120 load rating up to 438 kg	36
DA0115RC linear guide up to 120 kg	37
Fittings and fixtures heavy duty rails	38
Fittings and fixtures assembly housing	46

---

## Milled heavy duty rails

Outline	52
Milled heavy duty rails	54
Types of rails	55
Materials	57
Outline milled heavy duty rails	58
3018 load rating up to 140 kg	60
3011 load rating up to 145 kg	61
4016 load rating up to 225 kg	62
7016 load rating up to 275 kg	63
4024 load rating up to 340 kg	64
5030 load rating up to 400 kg	65
7032 load rating up to 660 kg	66
8036 load rating up to 720 kg	68
9036 load rating up to 850 kg	69
10044 load rating up to 1000 kg	70
11044 load rating up to 1150 kg	71
15038 load rating up to 1500 kg	72
14555 load rating up to 2700 kg	74
4020 linear guide up to 245 kg	76
Fittings and fixtures linear guide	77

---

Legal notice/Company info	80
---------------------------	----

## Commitment to quality, as standard Guaranteed quality for over 90 years

In 1919 Wilhelm Leschhorn founded the cornerstone of his wholesale business of technical products with the launch of its "cooperation for measuring equipment mbH". In the beginnings, the family business specialised in an assortment of device parts, standardised parts and measuring equipment. In the following years the product line has regularly been updated and adapted to current market developments.

Since its creation Leschhorn focused on meeting client's needs for products within production chains and continues its corporate philosophy of "Everything out of one hand" until the present day.



Leschhorn Logo – the original  
Leschhorn catalogue of standardised parts from 1959

## Specialist with multiple skills

For over 90 years Leschhorn has been your partner for industrial business-to-business trade of technical products. To deliver our promise of being a "guarantor for quality and performance", we continuously work with our engineers and experts to design innovative and purpose built products.

Our in-house production enables us to offer custom made products even for small quantity orders.

Permanent monitoring of suppliers and product markets allow us to adapt our product line accordingly and to provide a regular up to date and customer-orientated product range.

We are currently an established supplier to well-known companies of different market sectors such as chemicals, pharmaceuticals, automobile and packaging technologies as well as utility companies and the mechanical engineering industries.

Our clients now number around 7000 national and international companies that are currently in long term business relations with Leschhorn. Over the years these relationships evolved to being trustful partnerships, which shows that we are on the right track. It is the guarantee of long term partnerships based on trust, competence and responsibility that draws clients back to Leschhorn as this represents our key focus.



Outline product program – Leschhorn's catalogue of measuring equipment from 1964 - the original

## Your advantages

- » We carry out your purchase for technical products
- » We guarantee planning reliability through an extensive stock on hand
- » An outstanding product range for a one stop fulfilment
- » One contact to assist all your orders
- » Reduced number of orders
- » Reduced administration fees
- » You can order with your familiar item number of the manufacturer - We transcode for you
- » Combined packaging and shipping for cost reduction on small quantities

## Service and flexibility

Carry out your entire purchase of products with us. As a system supplier of C parts, we are happy to integrate with your preferred suppliers and tailor for your specific product enquiry.

With our help you can reduce your stock to maximise your possibilities  
Contact us for your individual consultation today

## High quality brands

Leschhorn – technical components for industry and the manual trade - partners with many strong brands. Our listed manufacturers see Leschhorn as a reliable and competent partner in distributing a variety of products

Find a complete selection of our cooperations at [www.leschhorn.de](http://www.leschhorn.de).





## Our product line— Your versatile selection

To facilitate your selection we have compiled our extensive assortment of approx. 60 000 products into nine main groups.

*Find our full range of  
products in clear sortation online  
at [www.leschhorn.de](http://www.leschhorn.de).*

On the website you can comfortably research parts you are looking for through our overall search facility.

Should you have difficulties finding your desired product within our online range, we offer a variety of items on request. Feel free to contact us directly for enquiries!



01

### 01 Standardised Parts and Operational Technology

- » Handles and knobs
- » Handwheels
- » Clamping and tension levers
- » Hand cranks
- » Scale rings

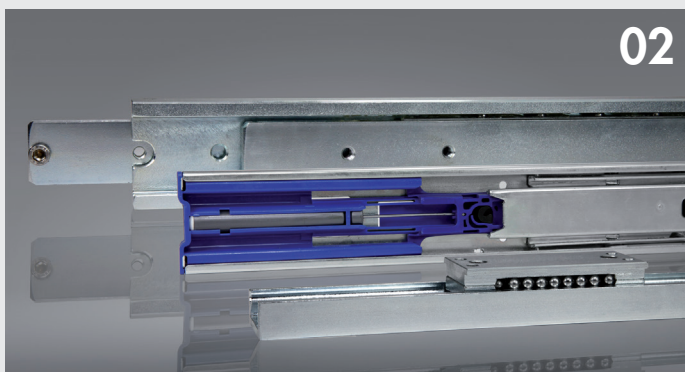

02

### 02 Telescopic Rails

- » Telescopic rails
- » Linear guides
- » Custom rails



03

### 03 Machinery and Device Parts

- » Drive technology
- » Bearing and mounting technique
- » Engagement and blocking devices
- » Drill bushes
- » Fluid technology

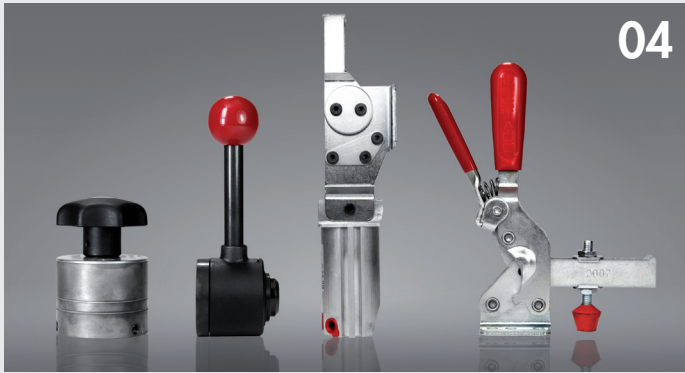

04

## 04 Clamping and Automation Technology

- » Manual-, pneumatic-, hydraulic clamping technology
- » Magnetic-, mechanic-, pneumatic clamping elements

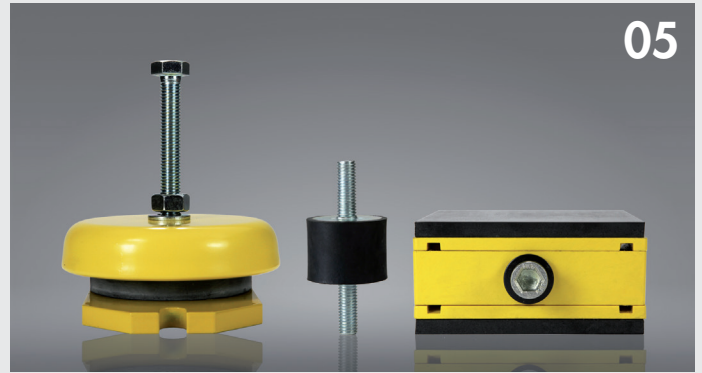

05

## 05 Vibration and Spring Technology

- » Rubber-metal technology
- » Machine bearing devices
- » Industrial shock absorbers
- » Springs

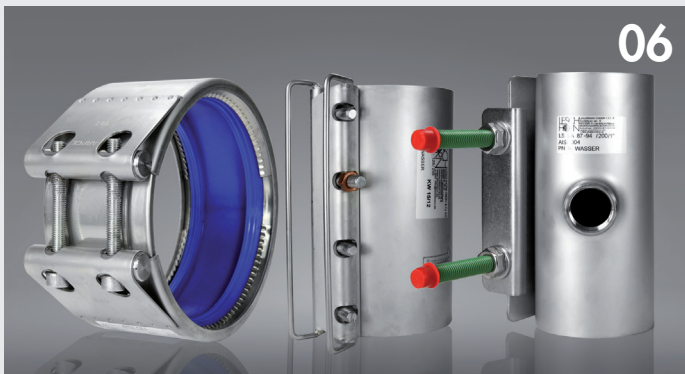

06

## 06. Pipe Connection Technology

- » Repair clamps
- » Pipe connections
- » Hose clamps



07

## 07 Positioning Systems

- » Cardanic positioning system - Karpos
- » Ball bearings
- » Position indicators
- » Pipe and Clamp connectors
- » Adjustable slides



08

## 08 Measuring Technique

- » Measurement technology
- » Dial gauges
- » Measuring tapes
- » Measuring systems



09

## 09 Industrial Technique

- » Pneumatic tools
- » Tools and instruments
- » Sensor technology
- » Pneumatic

With us you will always find the right route and person to contact!  
Our friendly team of consultants and experts is happy to help and guide you in the right direction

## Online Shop / Prices

From March 2013, we will update our website and online shop allowing you to find all our products and prices online and to easily place your orders directly from our website.

All the prices are to be understood as guidance prices without statutory value added tax (VAT). Items are often stated with scale prices to enable you to understand values for higher quantities.

Please mind that our online shop is still in developing stages and will therefore be continuously supplemented with new products. Should you be unable to find a particular product online, please contact us directly.



## Catalogue

The present catalogue 02 heavy duty rails comprises only one of nine product groups of Leschhorn's product spectrum. Our full range of products is to be found in printed form in our main catalogue and its supplement of innovative items.

A further subrange is to be found in our catalogue 06 Pipe connection technology. All catalogues are available to download from our website or to be send by mail on request.

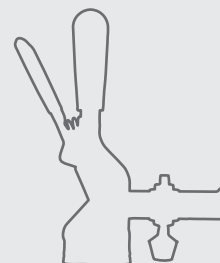

## Express-Service

Are you in a hurry? - Is your order especially urgent? Please let us know and we are eager to process your order as quickly as possible. Provided your enquiry consists of an item in stock and your order reaches us by 2pm, we can ensure next day delivery.

## Field representation

You have a special enquiry or prefer personal contact?

We are happy to visit you and deal with your individual requirements.

Our friendly and competent external staff are available to you throughout Germany and in German speaking areas abroad.



## Contact

Internet	<a href="http://www.leschhorn.de">www.leschhorn.de</a>
E-Mail	<a href="mailto:info@leschhorn.de">info@leschhorn.de</a>
Phone	004969 - 420 97 60
Fax	004969 - 41 92 38
Distribution	004969 - 42 09 76 19
Address	Schlitzerstraße 6 60386 Frankfurt Germany

vCard - QR Code





Type	Max. load rating kg	Profile h x w mm	Full extension	Part extension	Over extension	Extension in both directions	Zinc coated	Steel C45 zinc coated	Stainless steel	Aluminium	Arrester in closed position	Locking	Optional angle bracket	Description / other characteristics	Page
5321EC	100	53,1 x 19,1	✓				✓						✓	# For wide drawers, damped automatic retraction	16
5417	100	54,0 x 17,5			✓		✓				✓			# Optional horizontal mounting	17
3607	120	53,1 x 19,1	✓				✓					✓**	✓	# Rapid separation, optional horizontal mounting	18
5321-60	120	53,1 x 20,7			✓		✓				✓			# Angle mounting	19
DS5322	120	53,1 x 20,7			✓				✓		✓		✓	# Setting cams, corrosion resistant	20
5321SC	120	53,1 x 19,1			✓		✓				✓		✓	# Automatic retraction	21
DA4162	150	80,0 x 26,5			✓					✓				# Corrosion resistant	22
7957	160	70,8 x 19,1	✓				✓						✓	# Rapid separation, for wide drawers	24
5321	150 170	53,1 x 19,1			✓		✓						✓	#	26
DS5321	160 180	53,1 x 19,1			✓				✓					# Corrosion resistant	27
0522	180	95,5 x 26,5			✓		✓							# Shock absorbing blocks & mounting plate, rails available as singles	28
9301	227	76,2 x 19,1	✓				✓						✓	# optional horizontal mounting, rails available as singles	30
9308	227	76,2 x 19,1	✓				✓					✓***	✓	# Confirmation of front handle, rails available as singles	32
DA4160	300	80,0 x 26,5	✓							✓				# Corrosion resistant, sale in pairs	34
DA4140	400	150 x 38,0	✓							✓				# Corrosion resistant, rails available as singles	35
DA4120	438	80,0 x 36,0		✓						✓				# Optional horizontal mounting, corrosion resistant	36
DA0115SRC	120	40,0 x 12,3								✓				# Linear guide, optional horizontal mounting, corrosion resistant	37
3018	140	30 x 18	✓		✓*	✓		✓	✓	✓				## T-Profile****	60
3011	145	30 x 11		✓				✓	✓	✓				## C-Profile****	61
4016	225	40 x 16		✓				✓	✓	✓				## C-Profile****	62
7016	275	70 x 16	✓		✓*			✓	✓	✓				## S-Profile****	63
4024	340	40 x 24	✓		✓*	✓		✓	✓	✓				## T-Profile****	64
5030	400	50 x 30	✓		✓*	✓		✓	✓	✓				## T-Profile****	65
7032	660	70 x 32	✓		✓*	✓		✓	✓	✓				## T-Profile****	66
8036	720	80 x 36	✓		✓*	✓		✓	✓	✓				## T-Profile****	68
9036	850	90 x 36	✓		✓*	✓		✓	✓	✓				## T-Profile****	69
10044	1000	100 x 44	✓		✓*	✓		✓	✓	✓				## T-Profile****	70
11044	1150	110 x 44	✓		✓*	✓		✓	✓	✓				## T-Profile****	71
15038	1500	150 x 38	✓		✓*	✓		✓	✓	✓				## S-Profile****	72
14555	2700	145 x 55	✓		✓*	✓		✓	✓	✓				## T-Profile****	74
4020	245	20 x 40						✓	✓	✓				## Linear guide, U-profile, order carriage separately, rail length available from 300-3000 mm	76

\* Over extension available on request    \*\* Locking in extended position    \*\*\* Locking in extended and retracted position    \*\*\*\* Strain per pair in extended position  
# cold rolled steel    ## milled steel

---

# Heavy duty rails

---

» Heavy duty rails	10
» Types of rails	12
» Outline heavy duty rails	14
» 5321EC load rating up to 100 kg	16
» 5417 load rating up to 100 kg	17
» 3607 load rating up to 120 kg	18
» 5321-60 load rating up to 120 kg	19
» DS5322 load rating up to 120 kg	20
» 5321SC load rating up to 120 kg	21
» DA4162 load rating up to 150 kg	22
» 7957 load rating up to 160 kg	24
» 5321 load rating up to 170 kg	26
» DS5321 load rating up to 180 kg	27
» 0522 load rating up to 180 kg	28
» 9301 load rating up to 227 kg	30
» 9308 load rating up to 227 kg	32
» DA4160 load rating up to 300 kg	34
» DA4140 load rating up to 400 kg	35
» DA4120 load rating up to 438 kg	36
» DA0115RC linear guide up to 120 kg	37
» Fittings and fixtures heavy duty rails	38
» Fittings and fixtures assembly housing	46

---



## Extensive standard product range ex stock

*In Germany as well as in German speaking areas abroad the entire Accuride Quickship product range can be obtained by authorised distribution partners.*

Since its foundation in 1962 Accuride is the leading company in the development and manufacture of telescopic rails as well as access- and guide systems.

The products guarantee smooth action of its components, they contribute enormously to an optimal usage of space and efficient storage and further enable easy access for maintenance and repair works, according to European directive on machinery 2006/42/EG and 98/37EG.

Profit from an extensive standard product range of extending and linear guides! A multitude of standardised products is available ex stock and ready for delivery shortly after receipt of order. Despite extensive standardised solutions, high quality solutions can be produced for various different and specialised requirements.

### Manufacturer info

Accuride International is a global developer and manufacturer of ball bearing telescopic rails and pull out systems.



The company creates, produces and mounts all systems/components itself and therefore guarantees full control over all stages of the manufacturing process.

### Extended product range

Rails for smaller loads are also available. Beside the telescopic rails presented in this catalogue for heavy loads (load ratings from 100kg up to 438kg), Accuride rails for light (up to 50kg) and medium weight (50 to 99kg) load requirements can be obtained via Leschhorn. This also contains the media-hardware collection, rails with clip systems or rails with hanging frames.

### Quick delivery

The extensive Quick Ship program is especially adapted to clients needing a "readymade" service. Quick Ship offers a extensive range of rails and accompanying fittings and fixtures.

## Load rating

- » Unless specified otherwise, the named lifting capacities are the highest reachable with a pair of vertically mounted guides with a 450mm distance between rails/runners. For bigger distances please contact Leschhorn for an initial consultation.
- » The load rating changes depending on the length of the rail. Please refer to the details on the appropriate specification sheet.
- » For wider drawers, rails with higher load ratings and widths are generally required to withstand higher lateral loads. Our technical department is happy to consult and support you on this matter.
- » The readings refer to the centre point of the drawers in extended position and are stated in kg.
- » The mentioned load ratings are dynamic and have a statistic safety factor of 100% in the extended position.
- » A flat/horizontal installation of the rails reduces the load capacity by approx. 25% of the vertical loading rating. Not all rails are suited for a vertical installation.

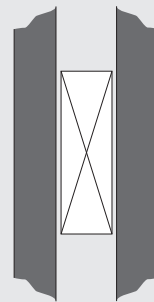

vertically mounted =  
100% named load rating

horizontally mounted =  
25% named load rating

- » The subsidence of horizontally mounted telescopic rails varies depending on its application. We recommend the construction of a prototype to identify if the subsidence lies within acceptable parameters.
- » We further advise our clients to test rails in the allocated application.
- » All fixation points have to be used in order to reach the maximum loading rate.
- » Appropriate fixation points must be used.

## Specifics for load ratings

Type 9301/9308



The Accuride load ratings stated at the bottom represent typical applications and consider possible factors that can affect the performance of the rail.

Generally to consider: Lower load ratings apply to rails on extensions or drawers, which are wider than they are long. These also have rails with many loads and high cycles.

**Moderate usage up to 227kg**  
Load rating based on a 457,2mm rail with a 450 mm wide drawer, 10.000 cycles. A computer server-storage unit could be cyclically loaded once a month for maintenance purposes. Electronic instrumentation could be cyclically loaded several times a week. Typical applications are computer server-storage units or electronic instrumentation chassis.

**Frequent usage up to 182kg**  
Load rating based on a 457,2 mm rail in 1000 mm wide drawer, 75.000 cycles.

Example: Drawer will be opened and closed 3 times per hour during an 8 hours working day. This results in 60.000 cycles over a 10 year period. Typical applications are high-performance storage drawers, large pantry extensions or modular storage cupboards.

Mobile (vehicle) up to 136kg  
Load rating based on a 457,2 mm rail in 800 mm wide drawer, 10.000 cycles. For applications in combination with transport, vibration and rough usage, we recommend an additional safety lock for the 9308.

**Mobile (vehicle) up to 136 kg**  
Typical applications are leisure vehicle drawers, automotive battery extensions and cupboards in service vehicles.

**Horizontal Installation up to 45kg (not 9308)**  
Load rating based on a 457,2 mm rail in 812,8 mm wide drawer, 10.000 cycles. The subsidence of horizontally mounted telescopic rails varies depending on its application. We recommend the construction of a prototype to identify if the subsidence lies within acceptable parameters. Applicable at marginal installation space availabilities. Typical application: monitor cupboards

**Attention: This rail should never be used for sliding steps, platforms or any similar applications in which human loads are to be carried.**

Type 0522

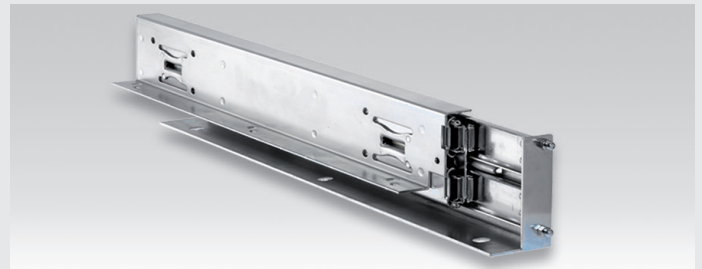

The Accuride load ratings stated at the bottom represent typical applications and consider possible factors that can affect the performance of the rail.

Please consult Leschhorn regarding particular applications for which the load rating could be critical.

Moderate usage up to 180kg  
Load rating based on a 600 mm rail in 500 mm wide drawer, 10.000 cycles.

Frequent usage up to 140kg  
Load rating based on a 600 mm rail in 500 mm wide drawer, 40.000 cycles.

**Attention: This rail should never be used for sliding steps, platforms or any similar applications in which human loads are to be carried. Simply vertical installation.**

## Mounting arrangement / Calculation of carrying capacity of a heavy duty rail

» For an example of the calculation of the carrying capacity and an accurate mounting instruction - refer to page 55.

## Full extension / Partial extension / Over extension

Extension models are to be chosen depending on stability criteria and the requirements of the installation dimensions.  
 The extension length of a partial extension is 75% the length of the rail.  
 A full extension allows a pull out of the rail equivalent to the length of the rail. An over extension allows a pull out of the rail further than the length of the rail.

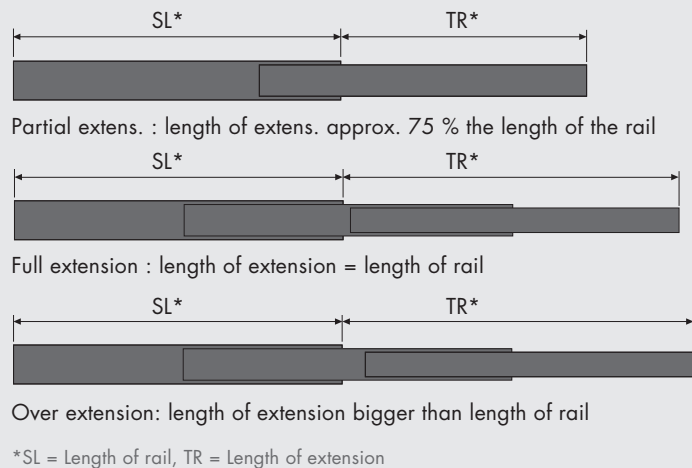

## Length of the rail (SL)

» The length of the rail equals the maximum length of a fully inserted rail.  
 Rule of thumb: Always use the maximum rail length possible for your purposes.

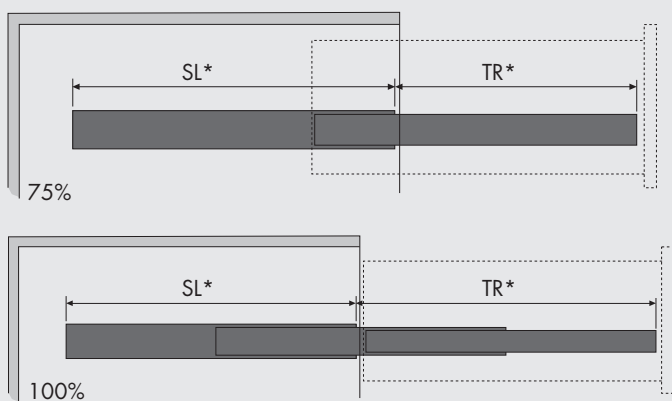

\*SL = Length of rail, TR = Length of extension

## Installation width

- » The installation width constitutes the space the rail requires between body and drawer.
- » For an optimal performance add +0.2 mm up to +0.5 mm of the rail's nominal thickness.  
 Example: For a rail with a nominal thickness of 12.7 mm the installation width should be between 12.9 mm and 13.2 mm.
- » Precision rails can not absorb huge gap aberrations between body and drawer. For optimal rail movement the body and drawer have to be accurate and parallel to each other.

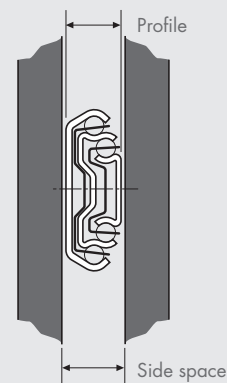

## Particular characteristics

- » A rapid separation allows a simple connection and removal of the drawer (3607, 7957, DS5322, find outline on p.14-15).  
Handle - After operating a handle the drawer can be removed.  
However the resistance of the ball cage has to be overcome.  
Mounting rail - After releasing a locking mechanism the drawer can be lifted from the rail.
- » The latch / engagement stabilises the rail in extended and closed position until additional pressure is applied to open or close it.
- » Locking mechanisms keep the rails in the inserted or extended position until a handle is operated.
- » Self-closing (SC): A spring device supports the complete closure of the drawer and further prevents a recoil in closed position.
- » Self-closing with damping (EC) slows down the closing process and creates an optimal and smooth rail movement.
- » The setting cams (DS5322, p. 20) for drawers facilitate the mounting process by allowing an exact vertical adjustment of the front of the drawers.
- » The damping pins are made of hardened steel pins which are applied in between the rail profiles and thus prevent the transfer of vibrations and absorb any damaging shocks. (0522, p. 28)
- » Mounting options are for example bayonet insertions or angle brackets
- » Suffix for standardised rail characteristics:  
SC – Self-closing, EC – Self-closing with damping, DS – Stainless steel, DA – Aluminium

## Material/Surface

(For exceptions refer to individual data sheets)

### Rail elements

- » cold-rolled non alloy steel
- » cold-rolled stainless steel 1.4301 (austenitic)
- » aluminium (series 6000)

### Ball cages

- » cold-rolled zinc coated
- » stainless steel 1.4301 (austenitic)
- » synthetics (PA 6.6)

### Balls

- » hardened steel
- » stainless steel 1.4034 (ferritic)
- » synthetics POM

### Lubricant

- » high-low temperature grease, temperature range -20°C up to +110°C

## Area of application

Accuride telescopic rails are created to be used in closed indoor spaces and should be protected from excessive moisture, chemical steam, dirt and corrosion.

The self-cleaning ball cages guarantee an undisturbed and maintenance free movement of the rail by preventing access to the ball storage by foreign particles. Additionally, a lubricant is used with equal durability to the rails when used under normal conditions. However, should cleaning of the rails still be necessary, its recommended to lubricate the rails after the cleaning process with a high quality lubricant and extremely high compression strength.

- » Accuride telescopic rails with synthetic or rubber components are created for use in a temperature range of between -17°C and 70°C.
- » Accuride telescopic rails without synthetics or rubber components can be used in a temperature range of between -20°C and 110°C.
- » Extreme high temperatures can have a damaging effect on the lubricant, synthetics and rubber components.

## Quality

Accuride can offer high quality products that reliably work over their entire life-span having first class manufacturing and testing plants in place.





Accuride rails manufactured in Germany do not contain any of the following, from EU directives specified dangerous materials: From 2000/53/EG over end-of-life vehicles (27.06.02), 2002/95/EG to the restriction of usage of particular dangerous materials in electro- and electronic devices (27.01.03), 2002/96/EG and electro- and electronic end-of-life devices (27.01.03).

## Restrictions on lifetime warranty



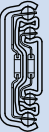
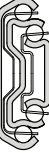

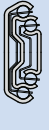
Leschhorn guarantees a warranty for faults in the material and processing defects. Excluded from the warranty are general wear and tear marks, rails that have been inappropriately used, inappropriately installed or have been used against the product instructions and thus been damaged. However, Leschhorn will send a replacement. This warranty does not cover the costs of dismantling, installation or other similar costs.

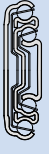
The restrictions on lifetime warranty only apply to rails that are being sold and used in the member states of the European Union or the European Economic Community. This warranty does not influence the legal warranty liability.

# Outline heavy duty rails

Type	max. Load rating kg	Profile H x B mm	Extension			Detent	Locking	Material			optional angle brackets	other characteristics	Page
			Full-	Par- tial-	Over-			Galva- nized steel	Stain- less steel	Alu- minium			
5321EC 	100	53,1 x 19,1	✓					✓			✓	for wide drawers, dampened self-insertion	16
5417 	100	54,0 x 17,5			✓	in closed position		✓				optional horizontal mounting	17
3607 	120	53,1 x 19,1	✓				in open position	✓			✓	rapid seperation, optional horizontal mounting	18
5321-60 	120	53,1 x 20,7			✓	in closed position		✓				angle moun- ting	19
DS5322 	120	53,1 x 20,7			✓	in closed position			✓		✓	Setting cams, corrosion resistant	20
5321SC 	120	53,1 x 19,1			✓	in closed position		✓			✓	self-closing	21
DA4162 	150	80,0 x 26,5			✓					✓		corrosion resistant	22
7957 	160	70,8 x 19,1	✓					✓			✓	Schnell- trennung, für breite Schubladen	24

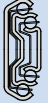

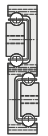
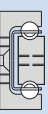
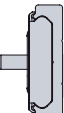
Type	max. Load rating kg	Profile H x B mm	Extension			Detent	Locking	Material			optional angle brackets	other characteristics	Page
			Full-	Partial-	Over-			Galvanized steel	Stainless steel	Aluminium			
5321 	150 170	53,1 x 19,1			✓	in closed position		✓			✓		26
DS5321 	160 180	53,1 x 19,1			✓	in closed position			✓			corrosion resistant	27
0522 	180	95,5 x 26,5			✓				✓			antishock blocks & mounting plates, rails available as singles	28
9301 	227	76,2 x 19,1	✓						✓		✓	optional horizontal mounting, rails available as singles	30
9308 	227	76,2 x 19,1	✓			in extended and inserted position			✓		✓	confirmation about front handle, rails available as singles	32
DA4160 	300	80,0 x 26,5	✓								✓	corrosion resistant, sale in pairs	34
DA4140 	400	150 x 38,0	✓								✓	corrosion resistant, rails available as singles	35
DA4120 	438	80,0 x 36,0		✓							✓	optional horizontal mounting, corrosion resistant	36
DA0115RC 	120	40,0 x 12,3									✓	optionale Horizontalmontage, korrosionsbeständig	37

## 5321EC



**Material**  
Galvanized steel, light passivated

**Load rating**  
Up to 100 kg

**Extension**  
Full extension

**Profile**  
H = 53,1 mm, B = 19,1 mm

### Description

- EC – Self-closing with damping
- Suitable for drawer width up to 1000 mm
- Extension power 25 N ± 5 N
- Soft Close-Damping system for the last 45 mm before closing
- Optional angle bracket fittings and fixtures for a diverse range of mounting possibilities

### Advice

- Recommended fixation: M5 countersunk head screw/Euro-countersunk head screw 6 mm
- Only vertical mounting
- We recommend the use of a centrally fitted pull handle for wide drawers
- Operational area 10°C - 40°C

### Fittings and fixtures

- Angle bracket fitting 635xx refer to page 42-45.

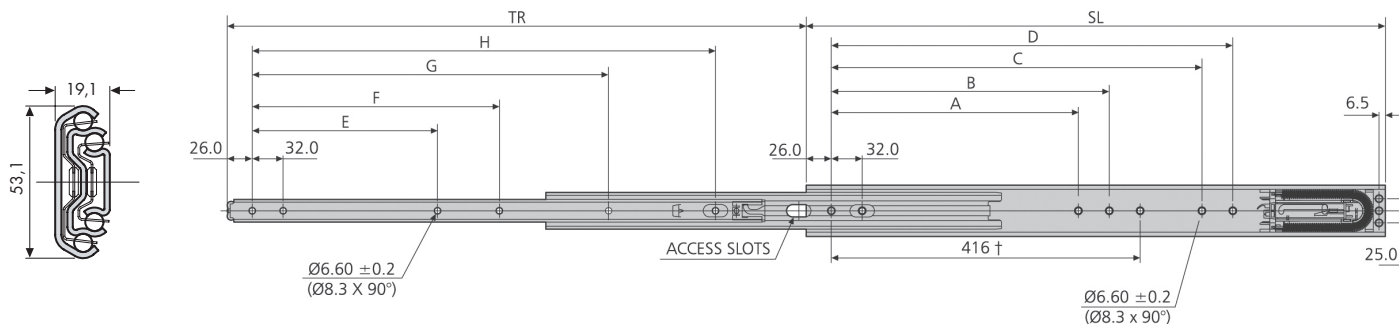
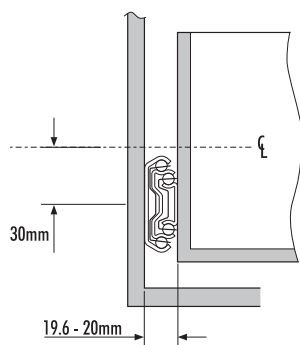

5321EC	SL	TR	A	B	C	D	E	F	G	H	W*	L* (450 mm**)	L** (1000 mm**)
	mm	mm	mm	mm	mm	mm	mm	mm	mm	mm	kg	kg	kg
DZ5321-0040EC	400	388	160	192	-	-	128	160	-	288	1,99	65	55
DZ5321-0045EC-A	450	450	160	192	256	-	128	160	-	320	2,27	65	55
DZ5321-0050EC	500	500	192	224	-	-	160	192	-	384	2,57	70	60
DZ5321-0055EC	550	550	192	224	320	352	160	192	-	416	2,87	85	72
DZ5321-0060EC	600	600	256	288	384	416	192	256	-	480	3,18	100	85
DZ5321-0070EC-A	700	700	288	320	448	480	256	288	512	576	3,79	100	85
DZ5321-0080EC-A	800	800	352	384	576	608	320	352	416	672	4,42	90	75

\* Weight and load rating per rail pair

\*\* Width of drawer

**Advice**

- Optional horizontal-mounting
- Recommended fitting: Wooden screw 4 mm/M4 countersunk head screw
- Max. head high 2.5 mm/Ø 9.6 mm
- If not specified otherwise the presented lifting capacities are the highest reachable for a pair of guides mounted side ways with 450 mm rail spacing.



- For more information refer to page 10-14.

## 5417

**Material**

Galvanized steel, light passivated

**Load rating**

Up to 100 kg

**Extension**

Over extension

**Detent**

In closed position

**Profile**

H = 54,0 mm, B = 17,5 mm

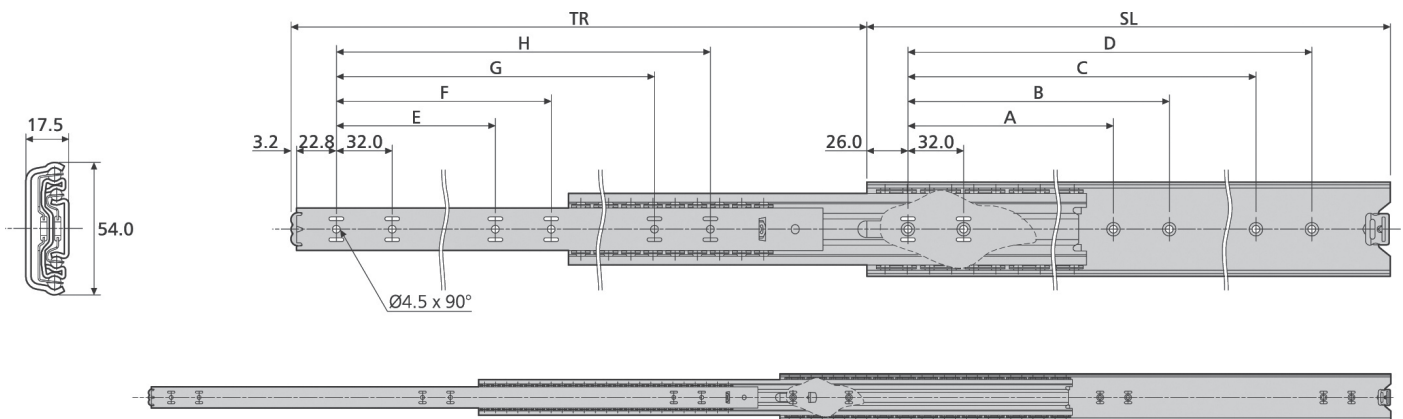

5417	SL mm	TR mm	A mm	B mm	C mm	D mm	E mm	F mm	G mm	H mm	W* kg	L* kg
DZ5417-0030	300	340	-	-	224	256	-	-	-	256	1,64	90
DZ5417-0035	350	389	-	-	224	256	-	-	-	256	1,93	90
DZ5417-0040	400	438	160	192	320	352	128	160	-	352	2,22	92
DZ5417-0045	450	487	160	192	320	352	128	160	320	352	2,53	95
DZ5417-0050	500	537	192	224	416	448	160	192	-	416	2,81	100
DZ5417-0055	550	586	224	-	448	480	160	192	-	448	3,12	100
DZ5417-0060	600	635	256	288	480	512	192	224	480	512	3,41	94
DZ5417-0065	650	684	288	320	544	576	192	256	-	544	3,68	92
DZ5417-0070	700	733	288	416	576	608	256	288	576	608	4,00	90

\* Weight and load rating per rail pair



## 3607

**Material**  
Galvanized steel, light passivated

**Load rating**  
Up to 120 kg

**Extension**  
Full extension

**Locking**  
In extended position

**Profile**  
H = 53,1 mm, B = 19,1 mm

### Description

- Frontal rapid separation
- Mounting components inclusive
- Optional assembly housing angles

### Advice

- Side specific mounting - handles move in the same direction once rail pair is installed
- Mounting components inclusive
- Only vertical mounting
- If not specified otherwise the presented lifting capacities are the highest reachable for a pair of guides mounted side ways with 450 mm rail spacing.

### Fittings and fixtures

- Angles for assembly housing refer to page 48–50.
- Cable tray refer to page 46–47.

- i**
- For more information refer to page 10–14.

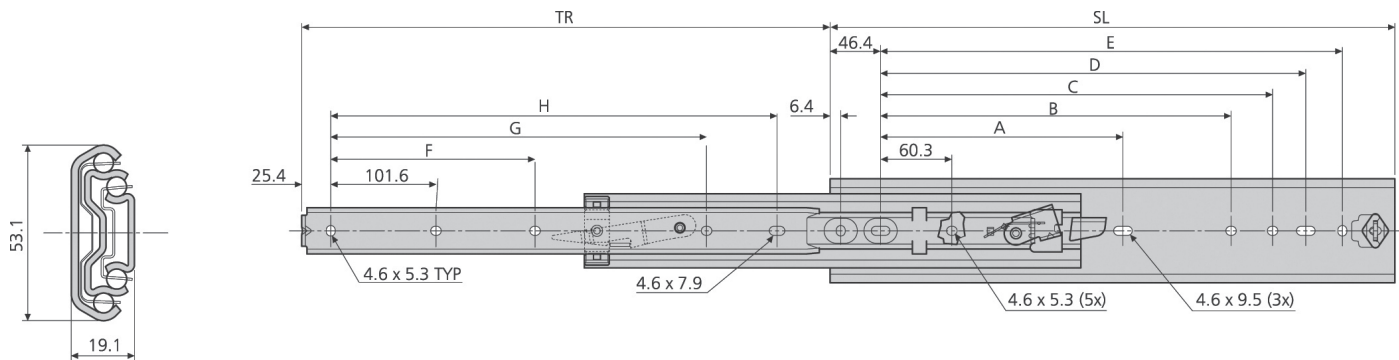

3607	SL mm	TR mm	A mm	B mm	C mm	D mm	E mm	F mm	G mm	H mm	W* kg	L* kg
DZ3607-0012-2	305	305	-	135,4	179,1	204,5	229,9	-	-	228,6	1,79	90
DZ3607-0014-2	356	356	-	186,2	229,9	255,3	280,7	-	-	279,4	2,08	90
DZ3607-0016-2	406	406	-	237,0	280,7	306,1	331,5	-	257,3	330,2	2,50	100
DZ3607-0018-2	457	457	-	287,8	331,5	356,9	382,3	-	308,1	381,0	2,71	110
DZ3607-0020-2	508	508	215,9	338,6	382,3	407,7	433,1	203,2	358,9	431,8	3,02	120
DZ3607-0022-2	559	559	241,3	389,4	433,1	458,5	483,9	228,6	409,7	482,6	3,32	110
DZ3607-0024-2	610	610	266,7	440,2	483,9	509,3	534,7	254,0	460,5	533,4	3,63	100
DZ3607-0026-2	660	660	292,1	491,0	534,7	560,1	585,5	279,4	511,3	584,2	3,95	92
DZ3607-0028-2	711	711	317,5	541,8	585,5	610,9	636,3	304,8	562,1	635,0	4,22	83

\* Weight and load rating per rail pair

**Description**

- Angle brackets for floor mounting

**Advice**

- Recommended fitting: Wooden screw 4 mm/M4 Countersunk head screw
- Max. head high 2.5 mm/Ø 9.6 mm
- If not specified otherwise the presented lifting capacities are the highest reachable for a pair of guides mounted side ways with 450 mm rail spacing.



- For more information refer to page 10-14.

## 5321-60

**Material**

Galvanized steel, light passivated

**Load rating**

Up to 120 kg

**Extension**

Over extension

**Detent**

In closed position

**Profile**

H = 53,1 mm, B = 20,7 mm

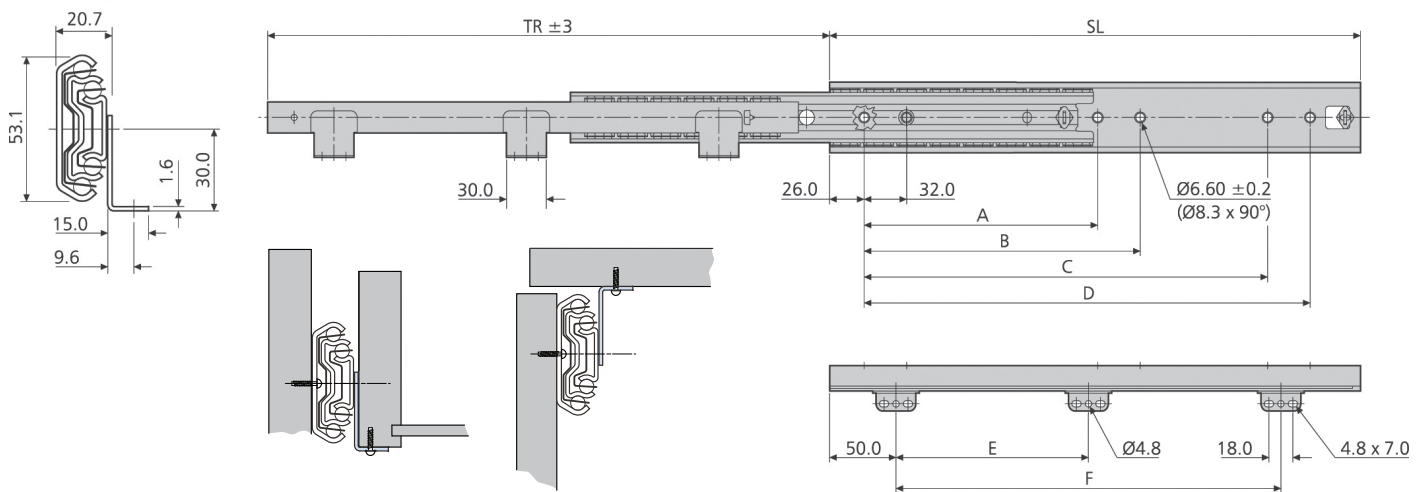

5321-60	SL mm	TR mm	A mm	B mm	C mm	D mm	E mm	F mm	W* kg	L* kg
DZ5321-6030	300,0	323,5	-	-	192	224	-	190	1,80	105
DZ5321-6035	350,0	373,5	-	-	224	256	-	240	2,12	110
DZ5321-6040	400,0	423,5	160	192	288	320	-	290	2,42	115
DZ5321-6045	450,0	473,5	160	192	320	352	-	340	2,73	120
DZ5321-6050	500,0	523,5	192	224	384	416	-	390	3,03	120
DZ5321-6055	550,0	573,5	192	224	416	448	250	440	3,37	120
DZ5321-6060	600,0	623,5	256	288	480	512	250	490	3,69	115
DZ5321-6070	700,0	723,5	288	320	576	608	250	590	4,29	107
DZ5321-6080	790,0	803,5	352	384	672	704	250	690	4,86	100

\* Weight and load rating per rail pair



## DS5322

**Material**  
High quality stainless steel

**Load rating**  
Up to 120 kg

**Extension**  
**Over extension**

**Detent**  
In closed position

**Profile**  
H = 53,1 mm, B = 20,7 mm

### Description

- Ideal for environments in which construction steel could corrode
- Simple drawer mounting using an angle bracket and bolt

### Advice

- Recommended fixation: M5 countersunk head screw/Euro-countersunk head screw 6 mm
- If not specified otherwise the presented lifting capacities are the highest reachable for a pair of guides mounted side ways with 450 mm rail spacing.

- For more information refer to page 10–14.

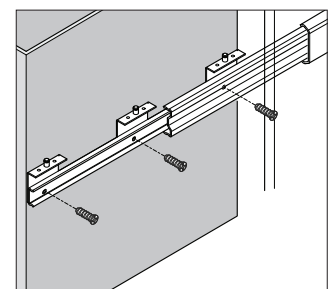
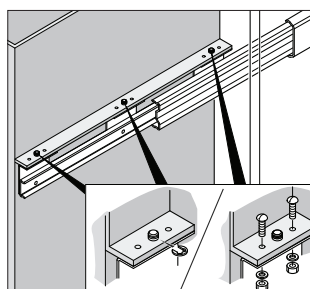
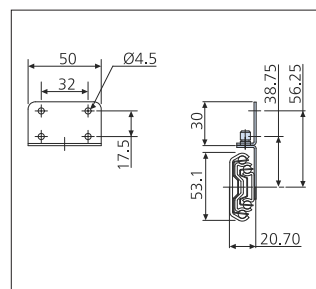
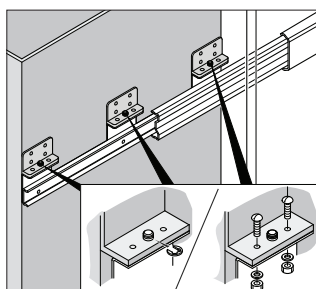
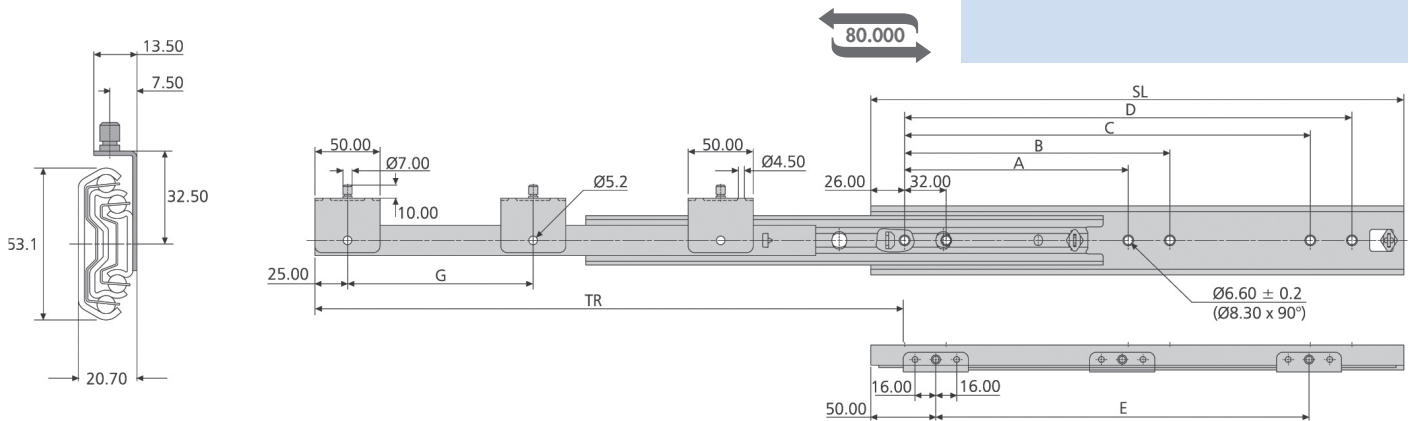

DS5322	SL	TR	A	B	C	D	E	G	W*	L*
	mm	mm	mm	mm	mm	mm	mm	mm	kg	kg
DS5322-0030-2	300	342	-	-	192	224	177	-	1,83	80
DS5322-0035-2	350	392	-	-	256	288	227	-	2,15	90
DS5322-0040-2	400	442	160	192	288	320	277	-	2,45	100
DS5322-0045-2	450	492	192	224	352	384	327	-	2,74	110
DS5322-0050-2	500	542	192	224	384	416	377	-	3,04	120
DS5322-0055-2	550	592	224	256	448	480	427	-	3,33	110
DS5322-0060-2	600	642	256	288	480	512	477	238,5	3,74	100
DS5322-0070-2	700	742	320	352	608	640	577	288,5	4,37	70
DS5322-0080-2	790	822	352	384	672	704	677	338,5	4,92	50

\* Weight and load rating per rail pair

### Description

- SC – Self-closing
- Holding in closed position
- Optional angle bracket for assembly housing

### Advice

- Recommended fixation:  
M5 countersunk head screw/Euro-countersunk head screw 6 mm
- Only vertical mounting
- If not specified otherwise the presented lifting capacities are the highest reachable for a pair of guides mounted side ways with 450 mm rail spacing.

### Fittings and fixtures

- Angle brackets for assembly housing refer to page 48–50.
- Cable tray refer to page 46–47.



- For more information refer to page 10–14.

## 5321SC

### Material

Galvanized steel, light passivated

### Load rating

Up to 120 kg

### Extension

Over extension

### Detent

In closed position

### Profile

H = 53,1 mm, B = 19,1 mm

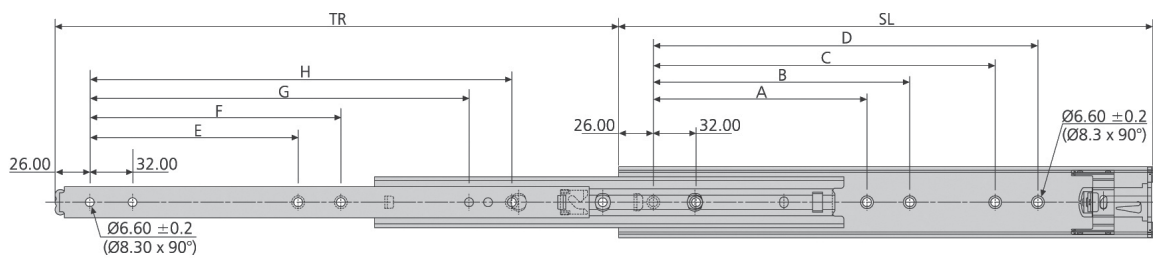
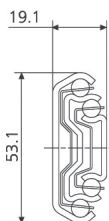
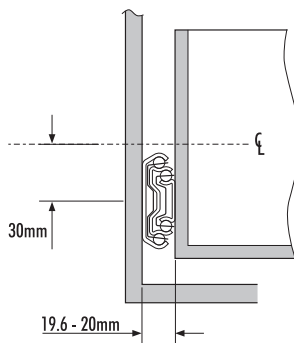

5321SC	SL	TR	A	B	C	D	E	F	G	H	W*	L*
	mm	mm	mm	mm	mm	mm	mm	mm	mm	mm	kg	kg
DZ5321-0030SC	300	319	-	-	160	192	-	-	192	224	1,64	85
DZ5321-0035SC	350	369	-	-	224	256	-	-	224	256	1,96	90
DZ5321-0040SC	400	419	160	192	256	288	160	192	288	320	2,25	100
DZ5321-0045SC	450	469	192	224	320	352	192	224	352	384	2,57	110
DZ5321-0050SC	500	519	224	256	352	384	224	256	384	416	2,87	120
DZ5321-0055SC	550	569	224	256	416	448	224	256	448	480	3,17	110
DZ5321-0060SC	600	619	256	288	480	512	256	288	480	512	3,48	100
DZ5321-0070SC	700	719	320	352	544	576	320	352	576	608	4,10	70
DZ5321-0080SC	790	823	352	384	640	672	352	384	672	704	4,64	50

\* Weight and load rating per rail pair



## DA4162

**Material**  
Aluminium rail – series 6000

**Load rating**  
Up to 150 kg

**Extension**  
**Over extension**

**Profile**  
H = 80,0 mm, B = 26,5 mm

### Description

- Ball cages and balls of stainless steel
- Corrosion resistant

### Advice

- The lifting capacity refers to a 600 mm rail pair spacing. These guides are suitable for wider applications
- Recommended fitting: M6/M8. All appropriate fitting points are to be used to reach the maximum loading rate.
- Only vertical mounting
- The end stops are tested, with the stated loading capacity by 10 cycles and a velocity of 0,8 m/s
- After exceeding 2000 cycles of movement we recommend to relubricate with a high quality high pressure lubricant.

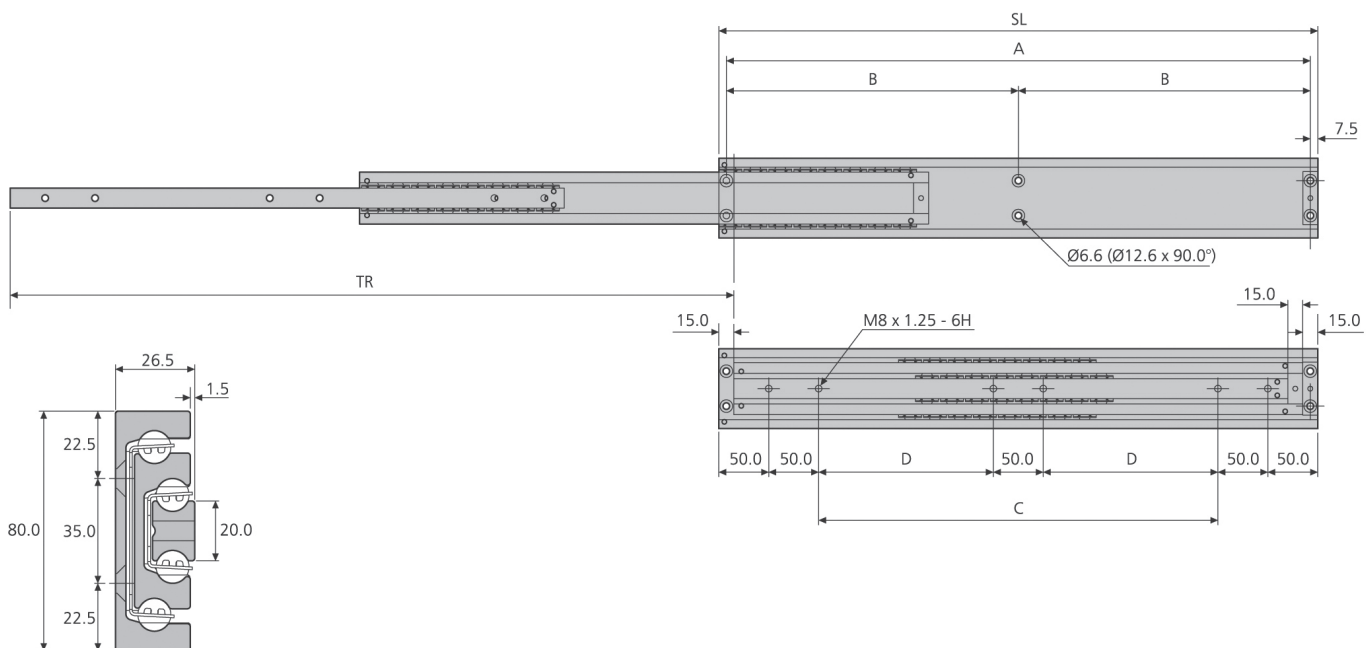

DA4162	SL	TR	A	B	C	D	W*	L*
	mm	mm	mm	mm	mm	mm	kg	kg
DA4162-0050	500	600	485	-	300	-	4,07	150
DA4162-0055	550	650	535	267,5	-	150	4,5	150
DA4162-0060	600	725	585	292,5	-	175	4,9	150

\* Weight and load rating per rail pair



A large grid of small dots for taking notes, covering the majority of the page.

## 7957

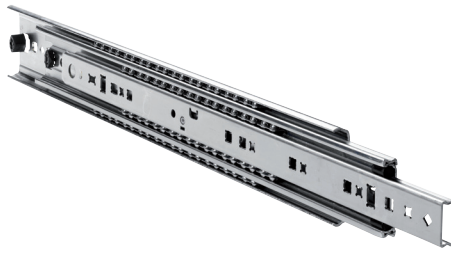

**Material**  
Galvanized steel, light passivated

**Load rating**  
Up to 160 kg

**Extension**  
Full extension

**Profile**  
H = 70,8 mm, B = 19,1 mm



### Description

- Suitable for drawer widths of 1000 mm
- Frontal rapid separation
- Optional angle fittings and fixtures for a divers range of mounting possibilities
- Optional horizontal-mounting

### Advice

- Recommended fitting: M5/M6 Countersunk head screw
- Side specific mounting - handles move in the same direction once the rail pair is installed.
- We recommend the use of a centrally fitted pull handle for wide drawers

### Fittings and fixtures

- Angle fittings and fixtures 635xxx refer to page 38-41.
- The enclosed screws do not fit the rail 7957. We therefore recommend the M6 countersunk head screw

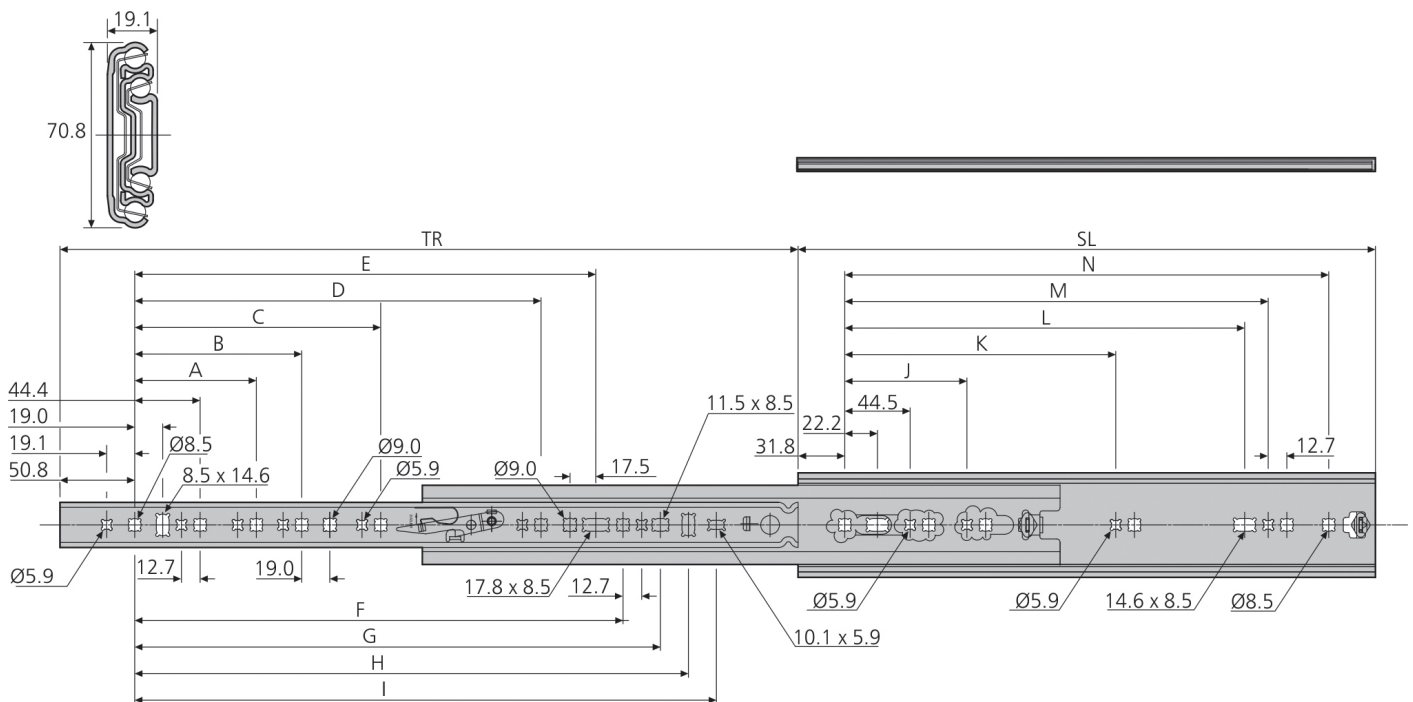

7957	SL mm	TR mm	A mm	B mm	C mm	D mm	E mm	F mm	G mm
DZ7957-0012-2	304,8	304,8	-	-	-	-	-	-	-
DZ7957-0014-2	355,6	355,6	-	-	-	-	-	-	-
DZ7957-0016-2	406,4	406,4	108,0	-	-	-	-	236,6	262,0
DZ7957-0018-2	457,2	457,2	108,0	-	-	-	-	287,4	312,8
DZ7957-0020-2	508,0	508,0	108,0	171,5	-	-	-	338,2	363,6
DZ7957-0022-2	558,8	558,8	108,0	171,5	-	-	328,7	389,0	414,4
DZ7957-0024-2	609,6	609,6	108,0	171,5	-	-	379,5	439,8	465,2
DZ7957-0026-2	660,4	660,4	108,0	171,5	-	-	430,3	490,6	516,0
DZ7957-0028-2	711,2	711,2	108,0	171,5	-	-	481,1	541,4	566,8
DZ7957-0030-2	762,0	762,0	108,0	171,5	-	-	531,9	592,2	617,6
DZ7957-0032-2	812,8	812,8	108,0	171,5	-	-	582,7	643,0	688,4
DZ7957-0034-2	863,6	863,6	108,0	171,5	349,3	-	633,5	693,8	719,2
DZ7957-0036-2	914,4	914,4	108,0	171,5	349,3	501,7	684,3	744,6	770,0

7957	H mm	I mm	J mm	K mm	L mm	M mm	N mm	W* kg	L* kg
DZ7957-0012-2	179,4	198,5	-	-	184,2	200,2	241,3	2,38	140
DZ7957-0014-2	230,2	249,3	-	-	235,0	251,0	292,1	2,80	140
DZ7957-0016-2	281,0	300,1	-	-	285,8	301,8	342,9	3,19	150
DZ7957-0018-2	331,8	350,9	-	-	336,6	352,6	393,7	3,62	150
DZ7957-0020-2	382,6	401,7	-	-	387,4	403,4	444,5	4,03	160
DZ7957-0022-2	433,4	452,5	-	-	438,2	454,2	495,3	4,42	160
DZ7957-0024-2	484,2	503,3	-	-	489,0	505,0	546,1	4,84	160
DZ7957-0026-2	535,0	554,1	-	-	539,8	555,8	596,9	5,27	160
DZ7957-0028-2	585,8	604,9	-	-	590,6	606,6	647,7	5,88	160
DZ7957-0030-2	636,6	655,7	203,2	469,9	641,4	657,4	698,5	6,06	160
DZ7957-0032-2	687,4	706,5	203,2	520,7	692,2	708,2	749,3	6,48	160
DZ7957-0034-2	738,2	757,3	203,2	571,5	743,0	759,0	800,1	6,88	160
DZ7957-0036-2	789,0	808,1	203,2	622,3	793,8	809,8	850,9	7,29	160

\* Weight and load rating per rail pair

---

## 5321



**Material**  
Galvanized steel, light passivated

**Load rating**  
Up to 150 / 170 kg

**Extension**  
Over extension

**Detent**  
In closed position

**Profile**  
H = 53,1 mm, B = 19,1 mm

### Description

Optional angle fittings and fixtures for a divers range of mounting possibilities  
· Optional angles for assembly housing

### Advice

- Recommended fixation:  
M5 countersunk head screw/Euro-countersunk head screw 6 mm
- Only vertical mounting
- If not specified otherwise the presented lifting capacities are the highest reachable for a pair of guides mounted side ways with 450 mm rail spacing.

### Fittings and fixtures

- Angles for assembly housing refer to page 48–50.
- Cable trays refer to page 46–47.

- i** For more information refer to page 10–14.

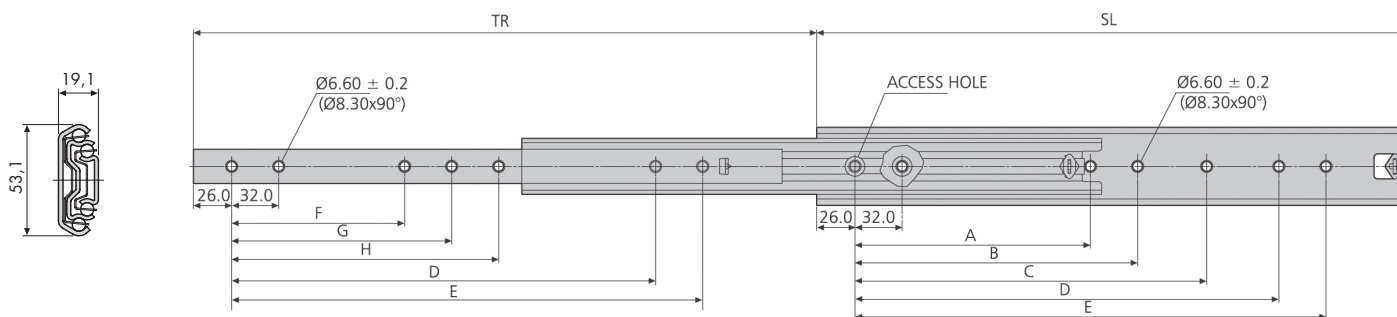
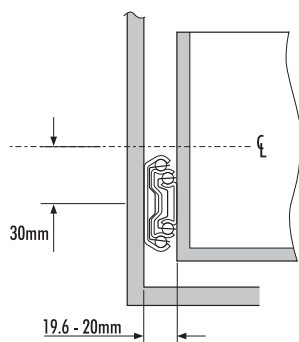

5321	SL	TR	A	B	C	D	E	F	G	H	W*	L* 10.000	L* 80.000
	mm	mm	mm	mm	mm	mm	mm	mm	mm	mm	kg	kg	kg
DZ5321-0030	300	323,5	-	-	-	192	224	-	-	-	1,78	130	120
DZ5321-0035	350	373,5	-	-	-	224	256	-	-	-	2,04	140	120
DZ5321-0040	400	423,5	-	160	192	288	320	128	160	-	2,34	150	130
DZ5321-0045	450	473,5	-	160	192	320	352	128	160	-	2,64	160	140
DZ5321-0050	500	523,5	-	192	224	384	416	160	192	-	2,94	170	150
DZ5321-0055	550	573,5	-	192	224	416	448	160	192	-	3,25	160	140
DZ5321-0060	600	623,5	-	256	288	480	512	192	256	-	3,55	150	120
DZ5321-A070	700	723,5	288	320	544	576	608	256	288	544	4,16	130	110
DZ5321-A080	790	803,5	-	352	384	672	704	320	352	384	4,72	100	100
DZ5321-A090	900	923,5	-	448	480	768	800	352	384	416	5,33	90	80
DZ5321-A100	1000	1023,5	448	480	512	864	896	448	480	-	5,87	80	70
DZ5321-A110	1100	1123,5	448	544	576	992	1024	448	480	512	6,39	70	60

\* Weight and load rating per rail pair

**Description**

- Ideal for environments in which construction steel could corrode

**Advice**

- Recommended fixation:  
M5 countersunk head screw/Euro-countersunk head screw 6 mm
- Only vertical mounting
- If not specified otherwise the presented lifting capacities are the highest reachable for a pair of guides mounted side ways with a 450 mm rail spacing.



- For more information refer to page 10-14.

## DS5321

**Material**

High quality stainless steel

**Load rating**

Up to 160 / 180 kg

**Extension**

Over extension

**Detent**

In closed position

**Profile**

H = 53,1 mm, B = 19,1 mm

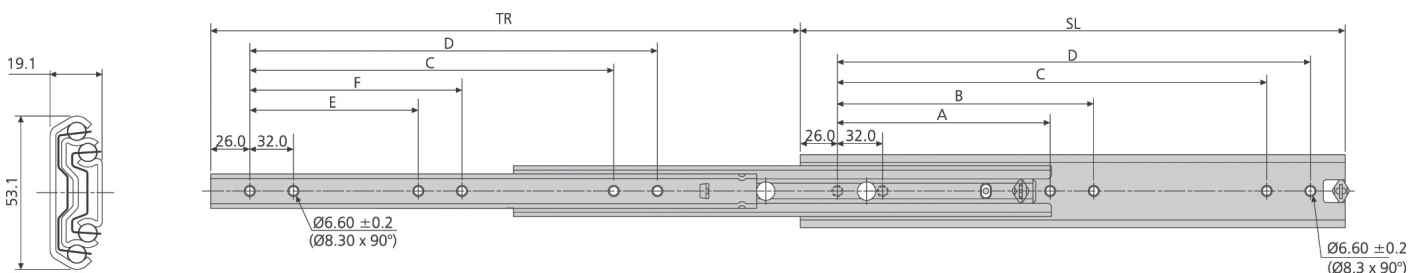
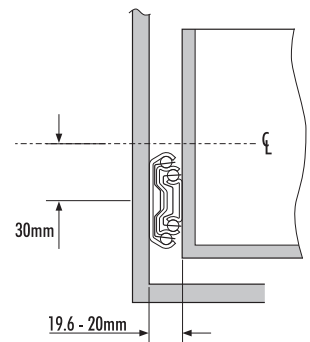

5321	SL	TR	A	B	C	D	E	F	W*	L* 10.000	L* 80.000
	mm	mm	mm	mm	mm	mm	mm	mm	kg	kg	kg
DS5321-0030	300	323,5	-	-	192	224	-	-	1,66	140	120
DS5321-0035	350	373,5	-	-	224	256	-	-	1,95	150	130
DS5321-0040	400	423,5	160	192	288	320	128	160	2,25	160	140
DS5321-0045	450	473,5	160	192	320	352	128	160	2,56	170	150
DS5321-0050	500	523,5	192	224	384	416	160	192	2,82	180	160
DS5321-0055	550	573,5	192	224	416	448	160	192	3,12	170	150
DS5321-0060	600	623,5	256	288	480	512	192	256	3,41	160	130
DS5321-0070	700	723,5	288	320	576	608	256	288	4,03	130	110
DS5321-0080	790	803,5	352	384	672	704	320	352	4,52	100	100

\* Weight and load rating per rail pair

# Heavy duty rails up to 180 kg

## 0522

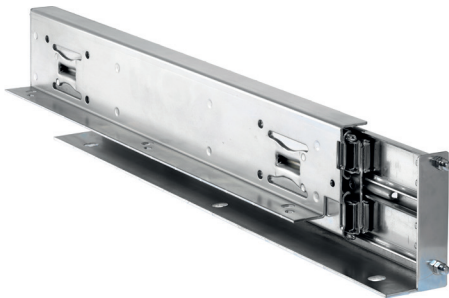

**Material**  
Galvanized steel, light passivated

**Load rating**  
Up to 180 kg

**Extension**  
Over extension

**Profile**  
H = 95,5 mm, B = 26,5 mm



### Description

- Rails available as singles
- Heavy duty construction
- Absorbing anti-shock blocks to protect against shock and concussion
- Coverage prevents the ball races from pollution
- Mounting angles on internal and external elements

### Advice

- DZ0522-1162 with additional fixation points (fourth hole) and distance A
- Recommended fixation: M6 screws at the extended internal side, M8 screws at the static external side rails pairwise
- Entire length (TL) = length of the rail + 24 mm
- Use all fixation points to reach the maximum load rating.
- Linking: large-scaled and buckle resistant



- Load rating can vary depending on application, refer to page 11.

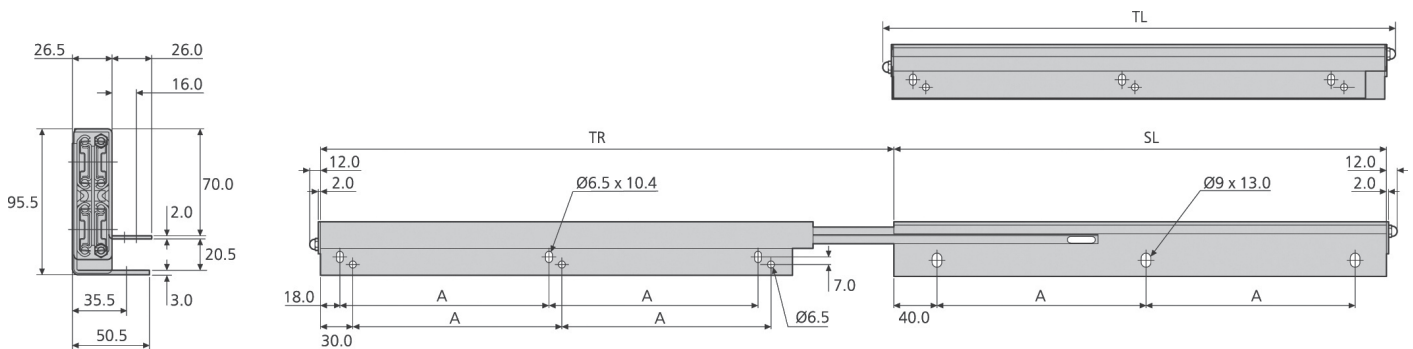

0522	SL mm	TL mm	TR mm	A mm	W** kg	L*** kg
DZ0522-1159*	457	481	534,0	194,0	4,87	180
DZ0522-1161*	600	624	625,0	265,0	6,34	180
DZ0522-1162*	900	924	907,0	276,5	9,62	150

\* State 'L' for left rail with locking and 'R' for right rail with locking, e.g. DZ0522-1159L

\*\* Weight per unit      \*\*\* Load rating per rail pair

A large grid of small dots for taking notes, covering the majority of the page.



## 9301

**Material**  
Galvanized steel, light passivated

**Load rating**  
Up to 227 kg

**Extension**  
Full extension

**Profile**  
H = 76,2 mm, B = 19,1 mm

### Description

- Rails available as singles
- Optional angle fittings and fixtures for a diverse range of mounting possibilities
- Optional horizontal-mounting
- Available lengths up to 1,5 m

### Advice

- Recommended fixation: screws M5/M6/ carriage bolts. Maximum bolt head of 4,8 mm and a 12,7 mm caliber

### Fittings and fixtures

- Angle fittings and fixtures refer to page 38–41.



- Load rating can vary depending on application, refer to page 11.



9301	SL mm	TR mm	A mm	B mm	C mm	D mm	E mm	F mm	G mm	H mm
DZ9301-0010U	254,0	254,0	-	-	-	-	-	103,1	128,5	142,6
DZ9301-0012U	304,8	304,8	-	-	-	-	-	153,9	179,3	198,4
DZ9301-0014U	355,6	355,6	-	-	-	-	-	204,7	230,1	249,2
DZ9301-0016U	406,4	406,4	127,0	-	-	-	-	255,5	280,9	300,0
DZ9301-0018U	457,2	457,2	127,0	-	-	-	246,1	306,3	331,7	350,8
DZ9301-0020U	508,0	508,0	127,0	190,5	-	-	296,9	357,1	382,5	401,6
DZ9301-0022U	558,8	558,8	127,0	190,5	-	-	347,7	407,9	433,3	452,4
DZ9301-0024U	609,6	609,6	127,0	190,5	-	-	398,5	458,7	484,1	503,2
DZ9301-0026U	660,4	660,4	127,0	190,5	-	-	449,3	509,5	534,9	554,0
DZ9301-0028U	711,2	711,2	127,0	190,5	-	-	500,1	560,3	585,7	604,8
DZ9301-0030U	762,0	762,0	127,0	190,5	368,3	-	550,9	611,1	636,5	655,6
DZ9301-0032U	812,8	812,8	127,0	190,5	368,3	-	601,7	661,9	687,3	706,4
DZ9301-0034U	863,6	863,6	127,0	190,5	368,3	469,9	652,5	712,7	738,1	757,2
DZ9301-0036U	914,4	914,4	127,0	190,5	368,3	520,7	703,3	763,5	788,9	808,0
DZ9301-0040U	1016,0	1016,0	127,0	190,5	368,3	520,7	804,9	865,1	890,5	909,6
DZ9301-0042U	1066,8	1066,8	127,0	190,5	368,3	520,7	855,7	915,9	941,3	960,4
DZ9301-0044U	1117,6	1117,6	127,0	190,5	368,3	520,7	906,5	966,7	992,1	1011,2
DZ9301-0048U	1219,2	1219,2	127,0	190,5	368,3	520,7	1008,1	1068,3	1093,7	1112,8
DZ9301-0060U	1524,0	1524,0	127,0	190,5	368,3	520,7	1312,9	1373,1	1398,5	1417,6



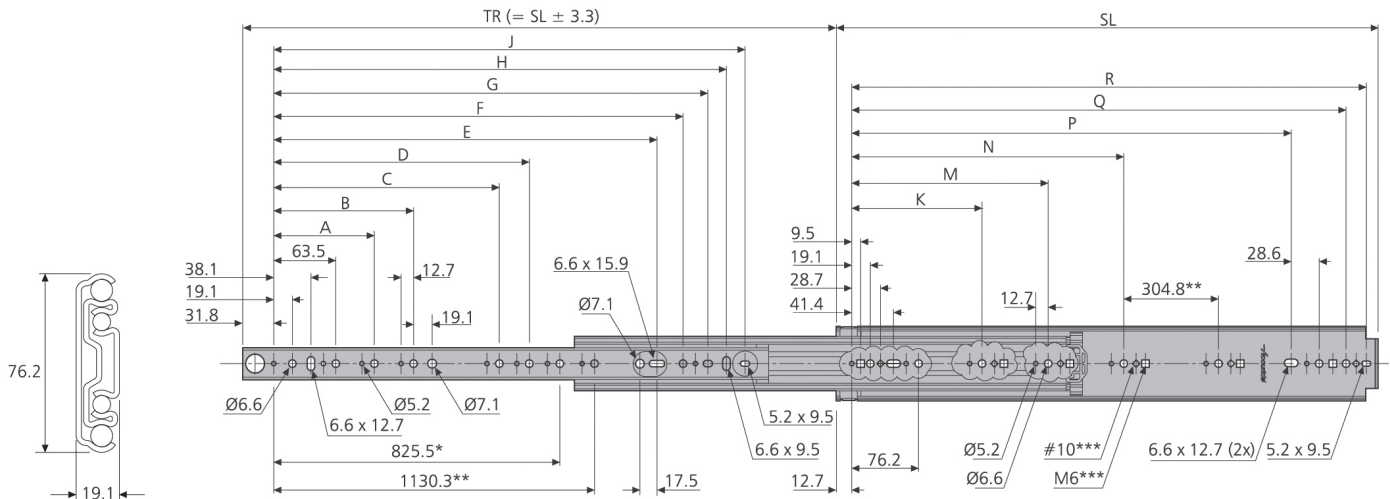

\* 9301-48/-60 \*\* 9301-60 \*\*\* Illustration for carriage bolt

9301	J mm	K mm	M mm	N mm	P mm	Q mm	R mm	W* kg	L** kg
DZ9301-0010U	166,6	-	-	-	152,4	209,6	228,6	1,15	227
DZ9301-0012U	217,4	-	-	-	203,2	260,4	279,4	1,40	227
DZ9301-0014U	268,2	-	-	-	254,0	311,2	330,2	1,64	227
DZ9301-0016U	319,0	-	-	-	304,8	362,0	381,0	1,90	227
DZ9301-0018U	369,8	-	-	-	355,6	412,8	431,8	2,15	227
DZ9301-0020U	420,6	-	-	-	406,4	463,6	482,6	2,38	227
DZ9301-0022U	471,4	-	-	-	457,2	514,4	533,4	2,61	227
DZ9301-0024U	522,2	-	-	-	508,0	565,2	584,2	2,88	227
DZ9301-0026U	573,0	-	-	-	558,8	616,0	635,0	3,13	227
DZ9301-0028U	623,8	-	-	-	609,6	666,8	685,8	3,37	227
DZ9301-0030U	674,6	235,0	-	501,7	660,4	717,6	736,6	3,62	222
DZ9301-0032U	725,4	235,0	393,7	552,5	711,2	768,4	787,4	3,86	218
DZ9301-0034U	776,2	235,0	419,1	603,3	762,0	819,2	838,2	4,15	213
DZ9301-0036U	827,0	235,0	444,5	654,1	812,8	870,0	889,0	4,37	209
DZ9301-0040U	928,6	235,0	546,1	755,7	914,4	971,6	990,6	4,88	200
DZ9301-0042U	979,4	235,0	546,1	806,5	965,2	1022,4	1041,4	5,11	195
DZ9301-0044U	1030,2	235,0	546,1	857,3	1016,0	1073,2	1092,2	5,35	182
DZ9301-0048U	1131,8	235,0	596,9	958,9	1117,6	1174,8	1193,8	5,86	182
DZ9301-0060U	1436,6	235,0	596,9	958,9	1422,4	1479,6	1498,6	7,32	154

\* Weight per unit

\*\* Load rating per rail pair

## 9308



**Material**  
Galvanized steel, light passivated

**Load rating**  
Up to 227 kg

**Extension**  
Full extension

**Locking**  
In extended and inserted position

**Profile**  
H = 76,2 mm, B = 19,1 mm



### Description

- Rails available as singles
- Confirmation about handle

### Advice

- Recommended fitting: M5/M6 Counter-sunk head screw
- Maximum bolt head height 4,8 mm and a 12,7 mm caliber
- Only vertical mounting
- Use rail 9301 as a supporting rail without locking.
- For locking on both sides order a pair of 9308 (L and R).

### Fittings and fixtures

- Angle fittings and fixtures refer to page 38–41.



- Load rating can vary depending on application, refer to page 11.



9308	SL mm	TR mm	A mm	B mm	C mm	D mm	E mm	F mm	G mm	H mm
DZ9308-0012*	304,8	304,8	-	-	-	-	-	153,9	179,3	198,4
DZ9308-0014*	355,6	355,6	-	-	-	-	-	204,7	230,1	249,2
DZ9308-0016*	406,4	406,4	-	-	-	-	-	255,5	280,9	300,0
DZ9308-0018*	457,2	457,2	127,0	-	-	-	-	306,3	331,7	350,8
DZ9308-0020*	508,0	508,0	127,0	-	-	-	296,9	357,1	382,5	401,6
DZ9308-0022*	558,8	558,8	127,0	190,5	-	-	347,7	407,9	433,3	452,4
DZ9308-0024*	609,6	609,6	127,0	190,5	-	-	398,5	458,7	484,1	503,2
DZ9308-0026*	660,4	660,4	127,0	190,5	-	-	449,3	509,5	534,9	554,0
DZ9308-0028*	711,2	711,2	127,0	190,5	-	-	500,1	560,3	585,7	604,8
DZ9308-0030*	762,0	762,0	127,0	190,5	-	-	550,9	611,1	636,5	655,6
DZ9308-0032*	812,8	812,8	127,0	190,5	-	-	601,7	661,9	687,3	706,4
DZ9308-0034*	863,6	863,6	127,0	190,5	-	520,7	652,5	712,7	738,1	757,1
DZ9308-0036*	914,4	914,4	127,0	190,5	368,3	520,7	703,3	763,5	788,9	807,9
DZ9308-0040*	1016,0	1016,0	127,0	190,5	368,3	-	804,9	865,1	890,5	909,5
DZ9308-0042*	1066,8	1066,8	127,0	190,5	368,3	-	855,7	915,9	941,3	960,4
DZ9308-0048*	1219,2	1219,2	127,0	190,5	368,3	520,7	1008,1	1068,3	1093,7	1112,8
DZ9308-0060*	1524,0	1524,0	127,0	190,5	368,3	520,7	1312,9	1373,1	1398,5	1417,8

\* State 'L' for left rail with locking and 'R' for right rail with locking, e.g. DZ9308-0012L

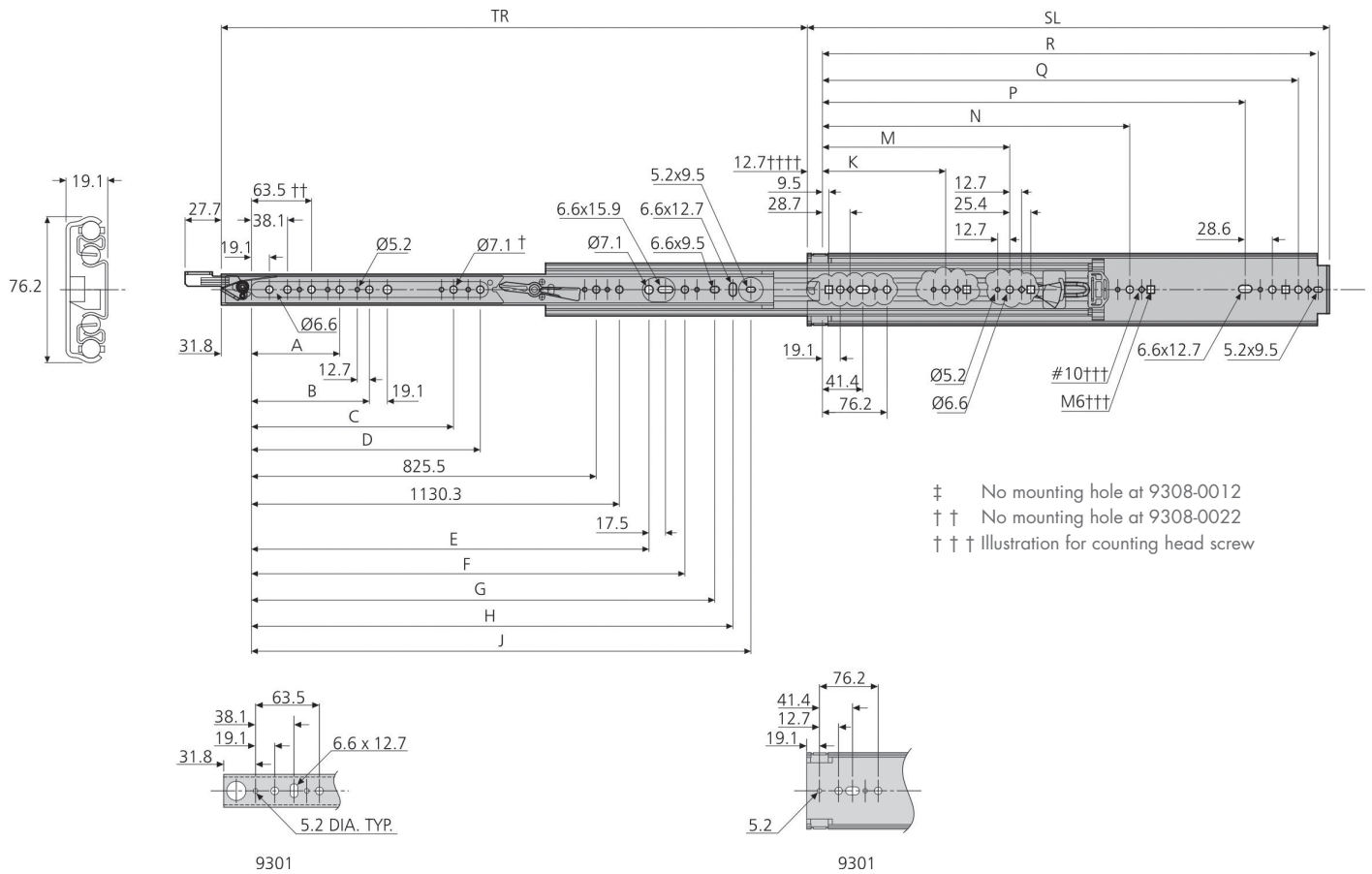

9308	J mm	K mm	M mm	N mm	P mm	Q mm	R mm	W** kg	L*** kg
DZ9308-0012*	-	-	-	-	203,2	260,4	279,4	1,46	227
DZ9308-0014*	-	-	-	-	254,0	311,2	330,2	1,71	227
DZ9308-0016*	-	-	-	-	304,8	362,0	381,0	1,97	227
DZ9308-0018*	-	-	-	-	355,6	412,8	431,8	2,21	227
DZ9308-0020*	-	-	-	-	406,4	463,6	482,6	2,45	227
DZ9308-0022*	-	-	-	-	457,2	514,4	533,4	2,69	227
DZ9308-0024*	-	-	-	-	508,0	565,2	584,2	2,96	227
DZ9308-0026*	-	-	-	-	558,8	616,0	635,0	3,20	227
DZ9308-0028*	-	-	-	-	609,6	666,8	685,8	3,46	227
DZ9308-0030*	-	235,0	-	501,7	660,4	717,6	736,6	3,71	222
DZ9308-0032*	-	235,0	-	552,5	711,2	768,4	787,4	3,98	218
DZ9308-0034*	-	235,0	-	-	762,0	819,1	838,2	4,22	213
DZ9308-0036*	-	235,0	-	654,1	812,8	869,9	889,0	4,49	209
DZ9308-0040*	-	235,0	-	755,7	914,4	971,5	990,6	5,03	200
DZ9308-0042*	-	235,0	-	806,5	965,2	1022,4	1041,4	5,27	195
DZ9308-0048*	-	235,0	-	958,9	1117,6	1174,8	1193,8	6,00	182
DZ9308-0060*	-	235,0	596,9	958,9	1422,4	1479,5	1498,6	7,54	154

\* State 'L' for left rail with locking and 'R' for right rail with locking, e.g. DZ9308-0012L  
 \*\* Weight per unit      \*\*\* Load rating per rail pair



## DA4160

### Material

Aluminium rail – series 6000, cage ball (1.4301) and balls (1.4021) of stainless steel

### Load rating

Up to 300 kg

### Extension

Full extension

### Profile

H = 80,0 mm, B = 26,5 mm

### Description

- Corrosion resistant
- Sale in pairs

### Advice

- The lifting capacity refers to a rail pair with a 600 mm spacing. These guides are suited for wider applications
- Recommended fixation: M6/M8. All fixation points are to be used in order to reach the maximum load rating.
- Only vertical mounting
- The end stops are tested with 10 cycles and a velocity of 0,8 m/s under the stated loadin
- After exceeding 2000 cycles we recommend the lubrication with a high quality high pressure lubricant.

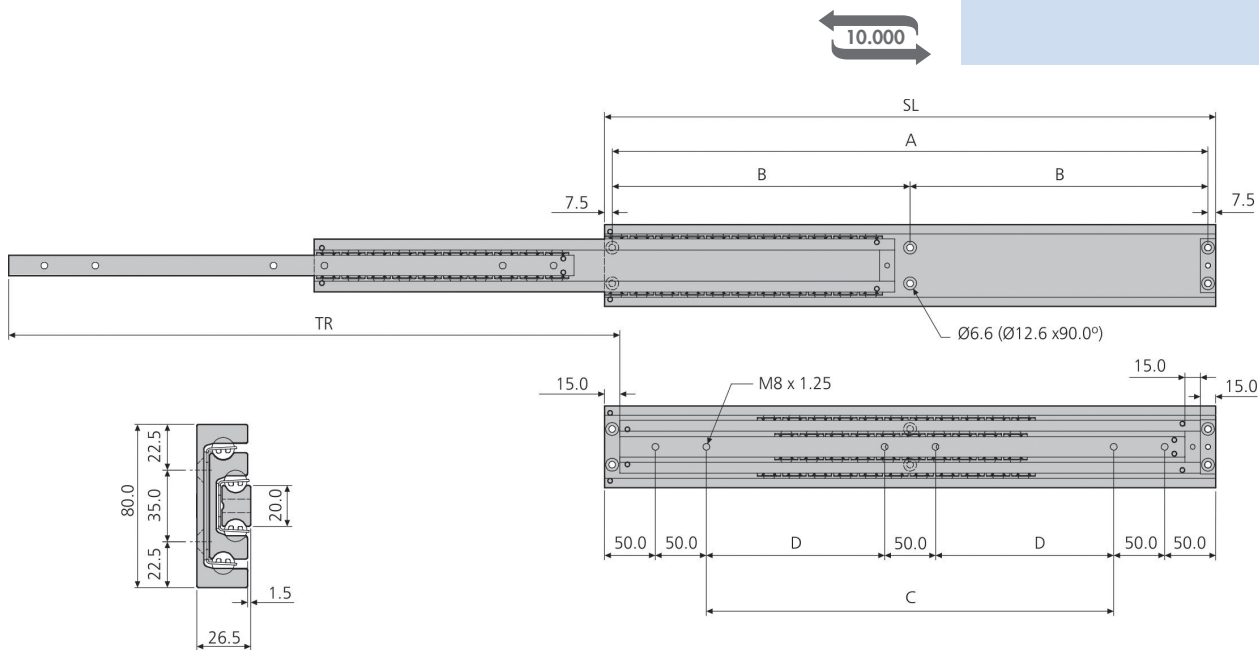

DA4160	SL mm	TR mm	A mm	B mm	C mm	D mm	W* kg	L* kg
DA4160-0030	300	300	285	-	100	-	2,50	240
DA4160-0035	350	350	335	-	150	-	2,93	255
DA4160-0040	400	400	385	-	200	-	3,37	270
DA4160-0045	450	450	435	-	250	-	3,80	285
DA4160-0050	500	500	485	-	300	-	4,24	300
DA4160-0055	550	550	-	267,5	-	150	4,68	300
DA4160-0060	600	600	-	292,5	-	175	5,12	300
DA4160-0065	650	650	-	317,5	-	200	5,56	295
DA4160-0070	700	700	-	342,5	-	225	6,00	290
DA4160-0080	800	800	-	392,5	-	275	6,87	270
DA4160-0090	900	900	-	442,5	-	325	7,75	250
DA4160-0100	1000	1000	-	492,5	-	375	8,62	230

\* Weight and load rating per rail pair

**Description**

- Corrosion resistant
- Rails available as singles

**Advice**

- The lifting capacity refers to a rail pair with a 600 mm spacing. These guides are suited for wider applications
- Recommended fixation: M8. All fixation points are to be used in order to reach the maximum load rating.
- Only vertical mounting
- The end stops are tested with 10 cycles and a velocity of 0,8 m/s under the stated loading
- After exceeding 2000 cycles we recommend the lubrication with a high quality high pressure lubricant.

## DA4140

**Material**

Aluminium rail – series 6000 cage ball (1.4301) and balls (1.4021) of stainless steel

**Load rating**

Up to 400 kg

**Extension**

Full extension

**Profile**

H = 150,0 mm, B = 38,0 mm

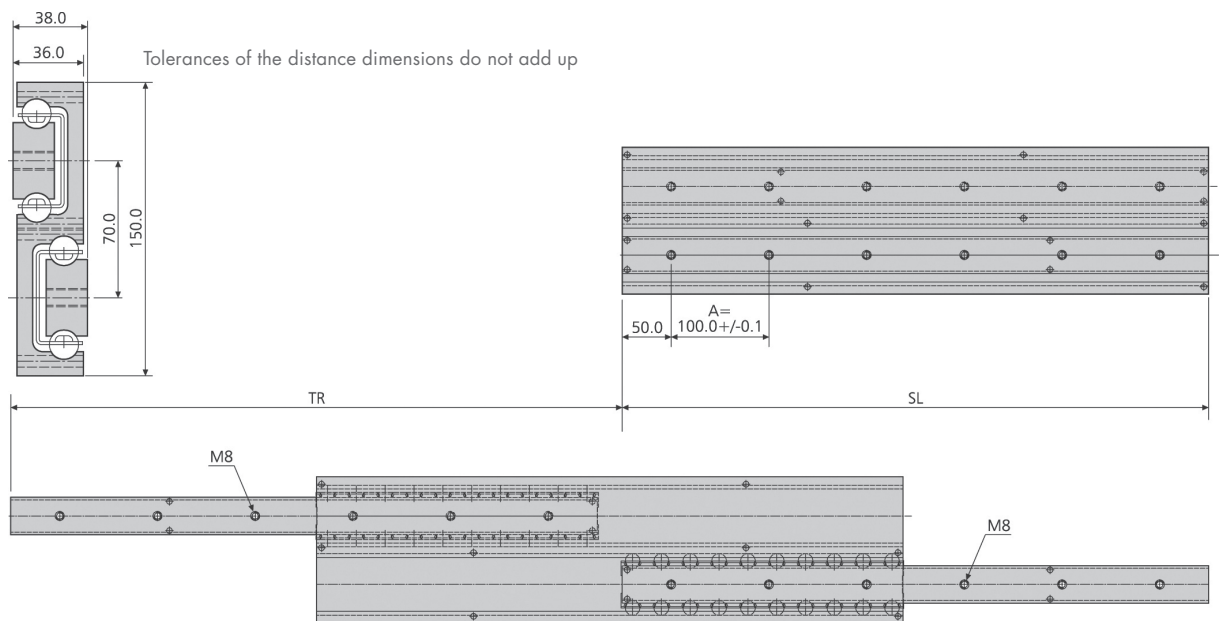
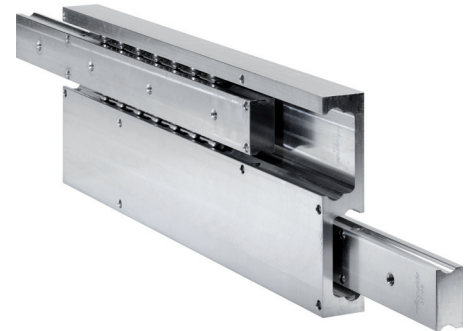

DA4160	SL mm	TR±3 mm	A mm	W* kg	L** kg
DA4140-0040	400	402	3x	4,71	400
DA4140-0050	500	543	4x	5,78	400
DA4140-0060	600	625	5x	7,01	400
DA4140-0070	700	707	6x	8,14	400
DA4140-0080	800	848	7x	9,22	400
DA4140-0090	900	930	8x	10,42	400
DA4140-0100	1000	1012	9x	11,61	400
DA4140-0110	1100	1153	10x	12,70	400
DA4140-0120	1200	1235	11x	13,93	400
DA4140-0150	1500	1540	14x	17,35	400

\* Weight per unit

\*\* Load rating per rail pair



## DA4120

**Material**  
Aluminium rail – series 6000 ball cages and balls of stainless steel

**Load rating**  
Up to 438 kg

**Extension**  
Partial extension

**Profile**  
H = 80,0 mm, B = 36,0 mm

### Description

- Corrosion resistant
- Rails available as singles
- Optional horizontal-mounting

### Advice

- The lifting capacity refers to a rail pair with a 600 mm spacing. These guides are suited for wider applications.
- Recommended fixation: M8. All fixation points are to be used in order to reach the maximum load rating.
- End stops are tested with 10 cycles, a 400 kg load and a velocity of 0,8 m/s. We recommend additional external end stops.
- Material characteristics: Aluminium rails – series 6000 ball cage and balls of stainless steel.
- After exceeding 2000 cycles we recommend the lubrication with a high quality high pressure lubricant.

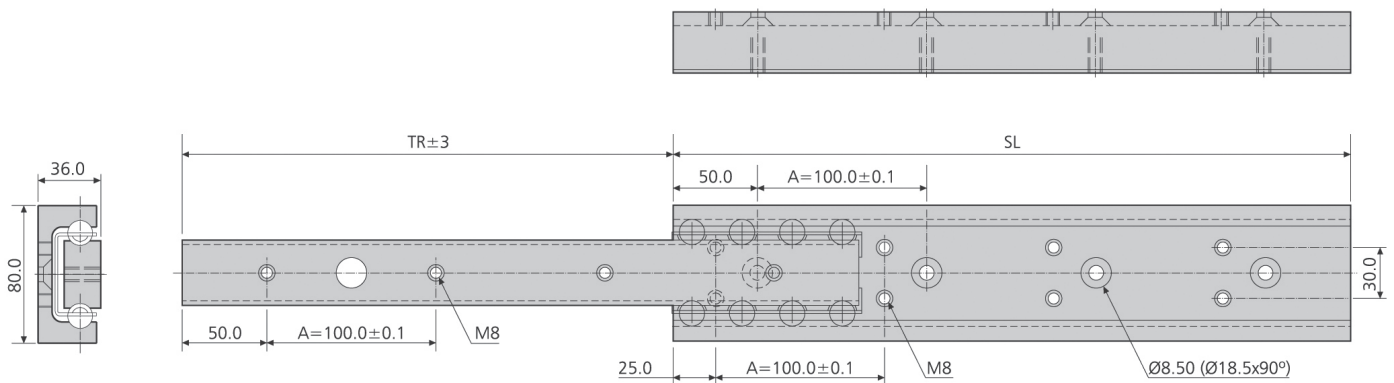

DA4120	SL mm	TR±3 mm	A mm	W* kg	# L** kg	## L** kg
DA4120-0040	400	290	3 x	2,35	370	185
DA4120-0050	500	360	4 x	2,93	390	195
DA4120-0060	600	430	5 x	3,53	400	200
DA4120-0070	700	501	6 x	4,11	410	205
DA4120-0080	800	572	7 x	4,68	420	210
DA4120-0090	900	642	8 x	5,30	425	212
DA4120-0100	1000	713	9 x	5,83	430	215
DA4120-0110	1100	783	10 x	6,40	434	217
DA4120-0120	1200	853	11 x	6,95	438	219

\* Weight per unit

\*\* Load rating per rail pair

# Vertically mounted ## Horizontally mounted

### Description

- Linear guide with ball carriage
- Aluminium rails, lengths 1,2 m und 2,4 m
- Customer cuts rail to the desired lengths and carries out drilling
- Ball carriage is available separately: Balls of stainless steel, synthetic balls: lubricant free, run smoothly
- Corrosion resistant, dirt and dust resistant
- End stops are available separately
- Different mounting possibilities

### Advice

- Recommended fixation: 4 mm-counter-sunk head screw/M4 countersunk head screw
- Install rail on strong and straight surface as stated.
- Be careful when injecting the carriage into the rail
- Unlimited lengths of rails are possible.
- Use a drilling template (separately available) and pins (not in the shipment) for a permanent connection.
- Please refer to the illustration for mounting possibilities and load ratings.

## DA0115RC

### Material

Rail: Aluminium  
Carriage: Stainless steel and nylon

### Load rating

Up to 120 kg

### Profile

H = 40 mm, B = 12,3 mm

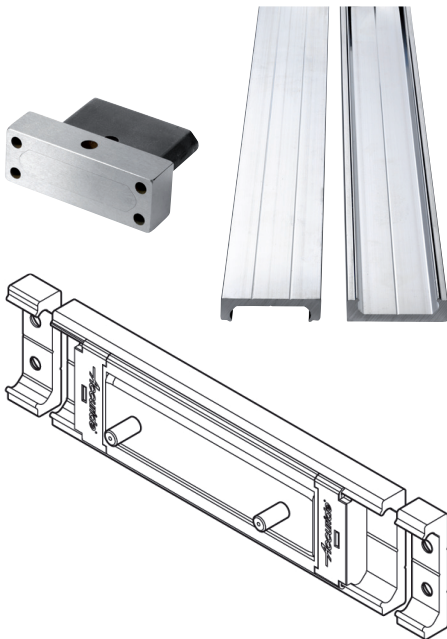
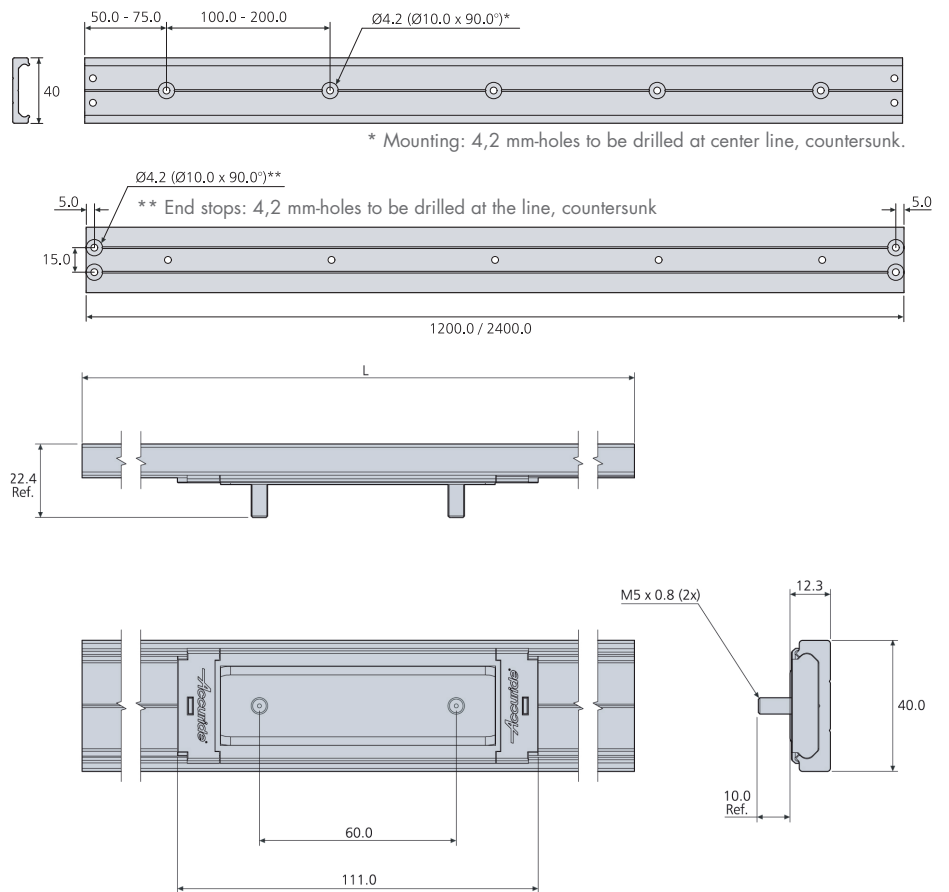

Product	Order number	W* kg
1,2 m-rail x 1 (without fixation holes)	DA0115-0120RC	0,635
2,4 m-rail x 1 (without fixation holes)	DA0115-0240RC	1,270
1,2 m-rail x 1 (with fixation holes x 12)	DA0115-0120RCH	0,635
2,4 m-rail x 1 (with fixation holes x 24)	DA0115-0240RCH	1,270
Carriage (balls of stainless steel) x 1	DS0115-CASSRC	0,120
Carriage (synthetic balls) x 1	DP0115-CASSRC	0,085
End stops (1 unit + 2 screws)	DA0115-STOPRC	0,007
Drilling template x 1	DZ0115-DJIGRC	0,080

\* Weight per unit

## 634xx Platform bracket

for 9301 / 9308 / 7957

Material: coiled rolled steel

Possible mounting: 4 on the bottom and 2 on the side

Brackets suit both sides

Fixation elements are inclusive for 9301 / 9308

Bracket lengths (BL):  
305 mm, 406 mm, 559 mm, 711 mm

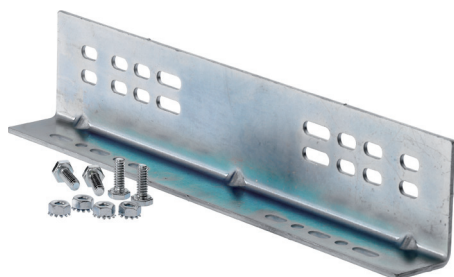

### Construction kit

- 2 x Brackets
- 4 x 6.4 x 15.9 Hexagonal head bolts
- 4 x 6.4 Hexagonal nuts and safety washers

### Advice

- Four bracket lengths can be used to cover all rail lengths, individually or in combination.
- The enclosed screws do not fit the rail 7957.
- We recommend the use of the M6 counting-sunk head screw. The customer provides consumables for the mounting process of brackets at the base or the platform/drawer.
- To find out the quantity of brackets needed refer to the table on page 40–41.

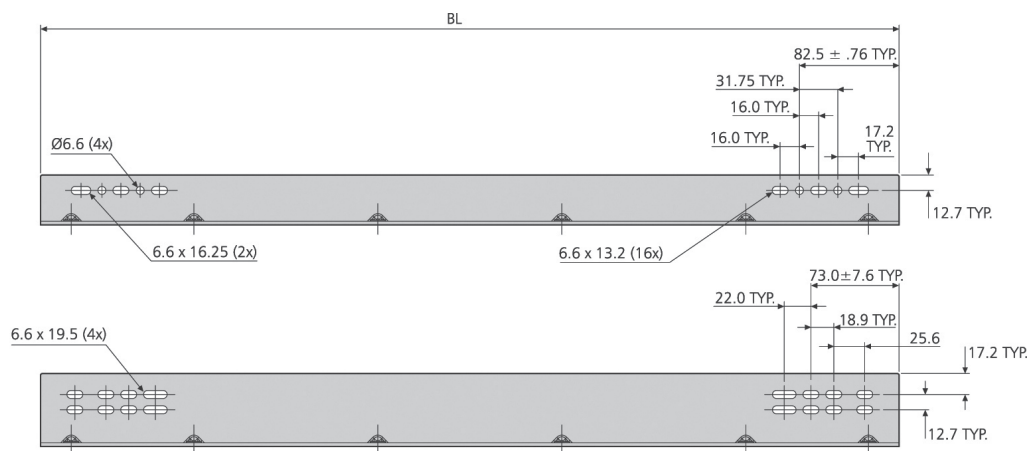
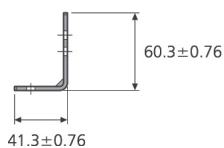

634xx	W kg
DZ63412	1,35
DZ63416	1,77
DZ63422	2,19
DZ63428	3,15



**S = Side mounting**

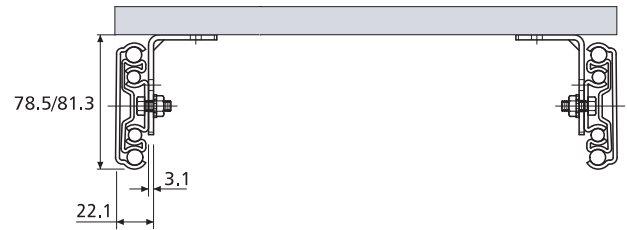
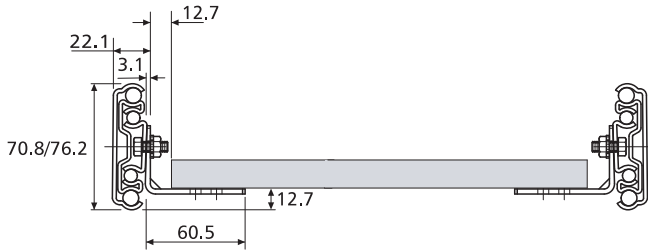

**B = Mounting at the bottom**

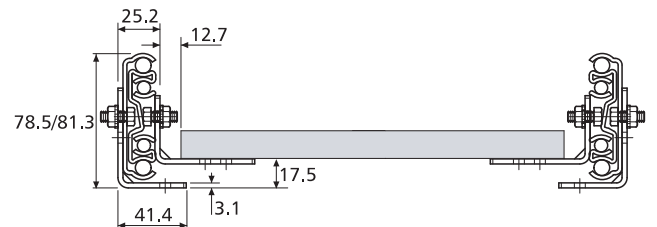
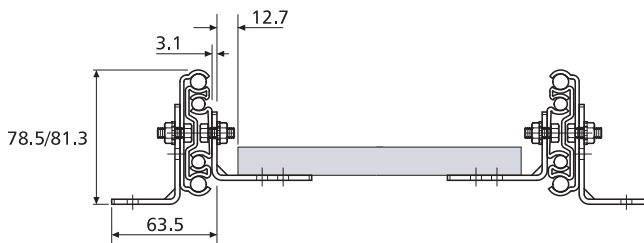
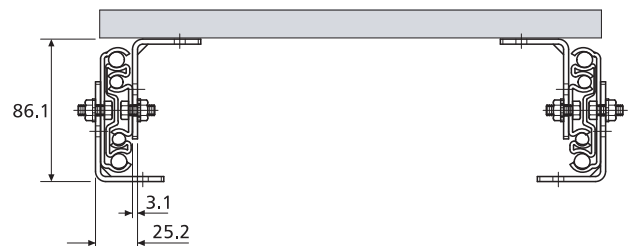
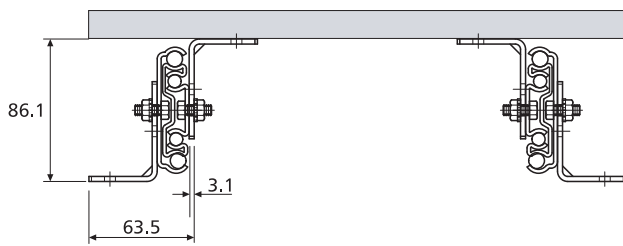

## 634xx Platform bracket

for 9301 / 9308 / 7957

Measurements only shown for general orientation

IM = Inside rail, OM = Outside rail

To find out the quantities of brackets needed refer to the table

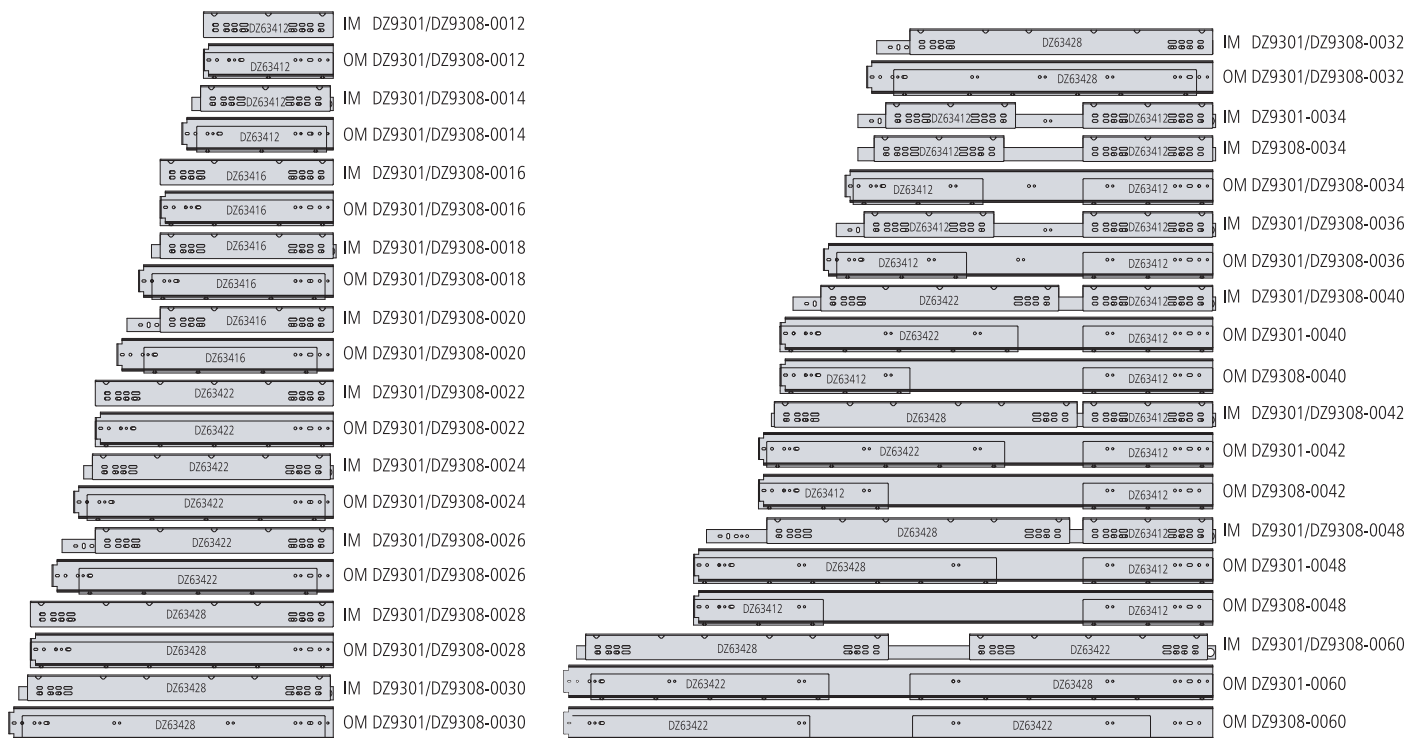

9301/9308	DZ63412-305mm		DZ63416-406mm		DZ63422-559mm		DZ63428-711mm	
	S	B	S	B	S	B	S	B
930x-0012	1	2	-	-	-	-	-	-
930x-0014	1	2	-	-	-	-	-	-
930x-0016	-	-	1	2	-	-	-	-
930x-0018	-	-	1	2	-	-	-	-
930x-0020	-	-	1	2	-	-	-	-
930x-0022	-	-	-	-	1	2	-	-
930x-0024	-	-	-	-	1	2	-	-
930x-0026	-	-	-	-	1	2	-	-
930x-0028	-	-	-	-	-	-	1	2
930x-0030	-	-	-	-	-	-	1	2
930x-0032	-	-	-	-	-	-	1	2
930x-0034	2	4	-	-	-	-	-	-
930x-0036	2	4	-	-	-	-	-	-
9301-0040	1	2	-	-	1	2	-	-
9308-0040	1	3	-	-	1	1	-	-
9301-0042	1	2	-	-	1	2	-	-
9308-0042	1	3	-	-	-	-	1	1
9301-0048	1	2	-	-	-	-	1	2
9308-0048	1	3	-	-	-	-	1	1
9301-0060	-	-	-	-	1	2	1	2
9308-0060	-	-	-	-	1	3	1	1

S = Side mounting    B = Mounting at the bottom

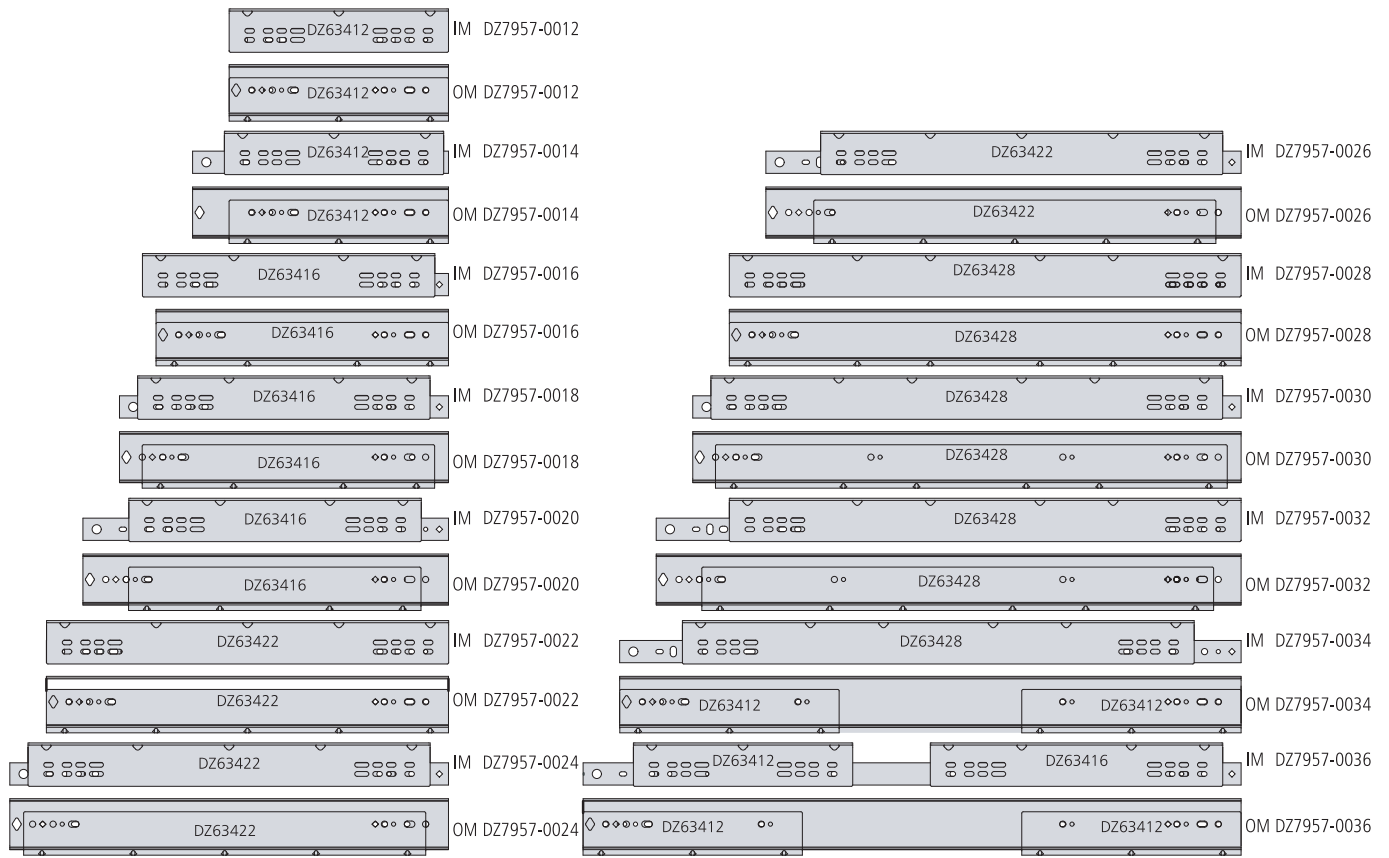

7957	DZ63412-305mm		DZ63416-406mm		DZ63422-559mm		DZ63428-711mm	
	S	B	S	B	S	B	S	B
7957-0012	1	2	-	-	-	-	-	-
7957-0014	1	2	-	-	-	-	-	-
7957-0016	-	-	1	2	-	-	-	-
7957-0018	-	-	1	2	-	-	-	-
7957-0020	-	-	1	2	-	-	-	-
7957-0022	-	-	-	-	1	2	-	-
7957-0024	-	-	-	-	1	2	-	-
7957-0026	-	-	-	-	1	2	-	-
7957-0028	-	-	-	-	-	-	1	2
7957-0030	-	-	-	-	-	-	1	2
7957-0032	-	-	-	-	-	-	1	2
7957-0034	-	2	-	-	-	-	1	1
7957-0036	1	3	1	1	-	-	-	-

S = Side mounting      B = Mounting at the bottom

## 635xx Platform bracket

for 5321 / 5321EC

Material: cold rolled steel

Mounting possibilities: 4 at the bottom and 3 on the side

Fixation components inclusive



### Construction kit

- 2 x Brackets
- 8/10/12 x Countersunk head screws, M5x10
- 8/10/12 x Nuts, M5
- 8/10/12 x Washers, M5

### Advice

- Four bracket lengths can be used to cover all rail lengths, individually or in combination.
- The customer provides consumables for the mounting process of the brackets at the base and/or the platform/drawer
- To find out the quantities of brackets needed refer to the table on page 43.

DZ63530

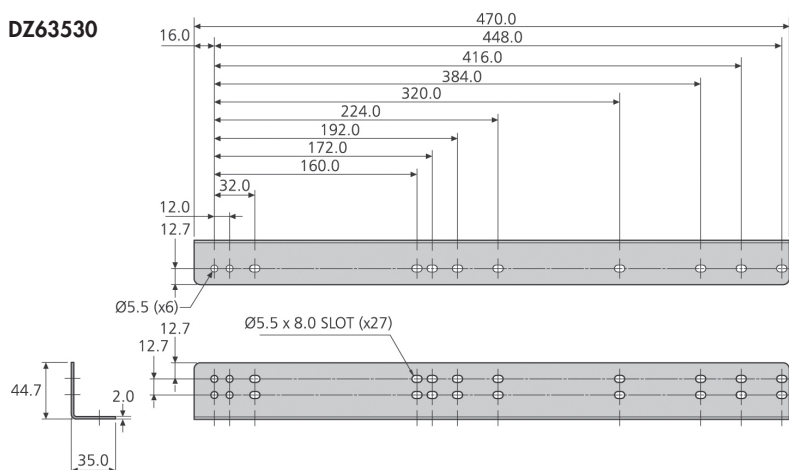

DZ63540

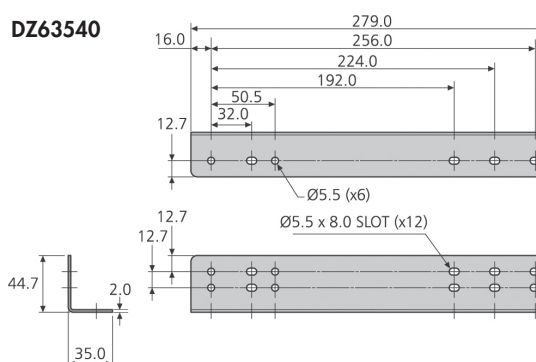

DZ63550

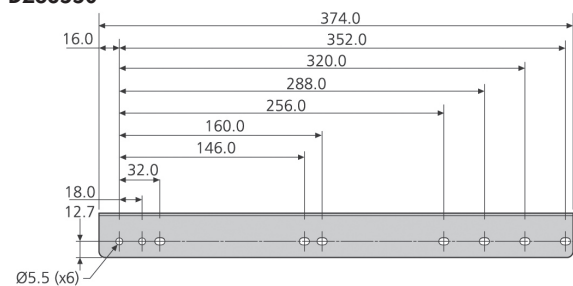

DZ63560

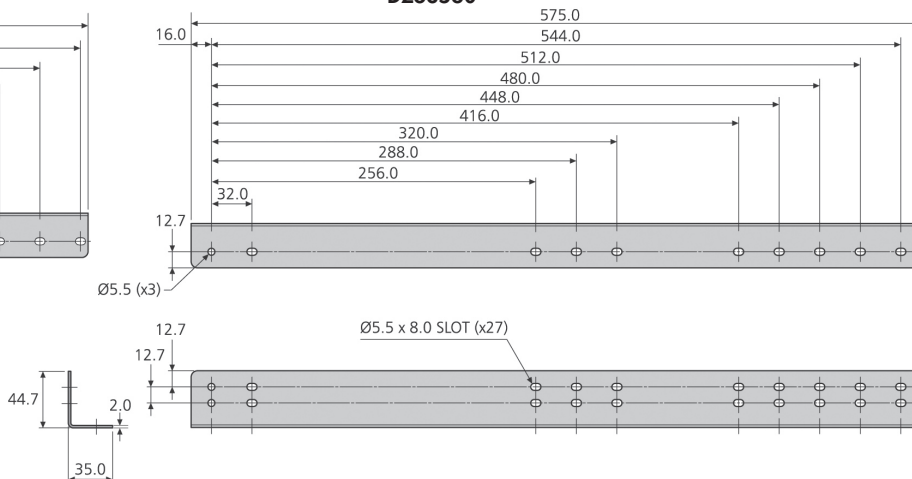

635xx	W kg
DZ63530	0,66
DZ63540	0,89
DZ63550	1,12
DZ63560	1,37

## S = Side mounting

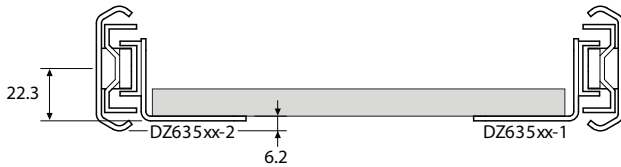
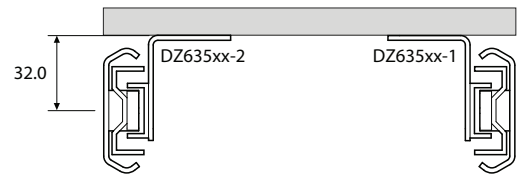
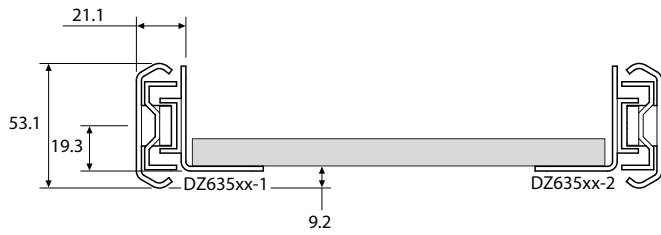

## B = Mounting at the bottom

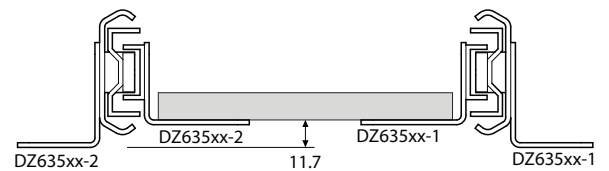
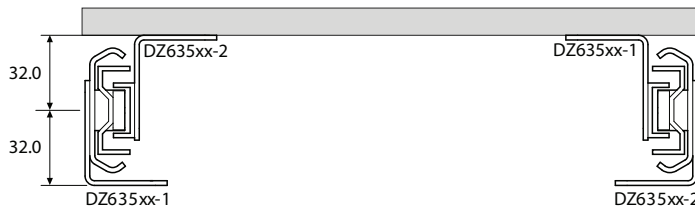
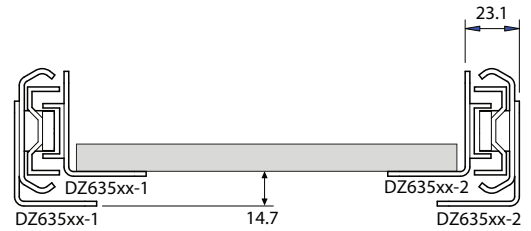
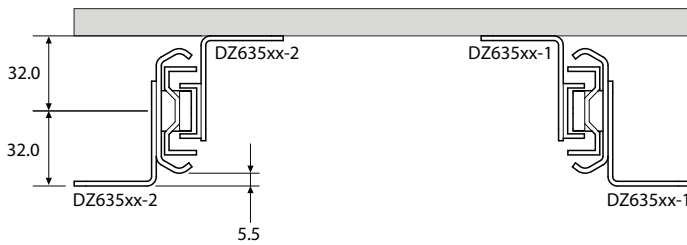

5321/ 5321EC	DZ63530		DZ63540		DZ63550		DZ63560	
	S	B	S	B	S	B	S	B
DZ5321-0030	1	2	-	-	-	-	-	-
DZ5321-0035	1	2	-	-	-	-	-	-
DZ5321-0040	-	-	1	2	-	-	-	-
DZ5321-0045	-	-	1	2	-	-	-	-
DZ5321-0050	-	-	-	-	1	2	-	-
DZ5321-0055	-	-	-	-	1	2	-	-
DZ5321-0060	-	-	-	-	-	-	1	2
DZ5321-0070-A	-	-	-	-	-	-	1	2
DZ5321-0080-A	-	-	2	4	-	-	-	-
DZ5321-0090-A	-	-	1	2	1	2	-	-
DZ5321-0100-A	-	-	-	-	2	4	-	-
DZ5321-0110-A	-	-	-	-	1	3	1	1
DZ5321-0040EC	-	-	1	2	-	-	-	-
DZ5321-0045EC-A	-	-	1	2	-	-	-	-
DZ5321-0050EC	-	-	-	-	1	2	-	-
DZ5321-0055EC	-	-	-	-	1	2	-	-
DZ5321-0060EC	-	-	-	-	1	2	1	2
DZ5321-0070EC-A	-	-	-	-	-	-	1	2
DZ5321-0080EC-A	-	-	2	4	-	-	-	-

S = Side mounting    B = Mounting at the bottom

## 635xx Platform bracket

for 5321 / 5321EC

Measurements only shown for general orientation

IM = Inside rail, OM = Outside rail

### 5321EC

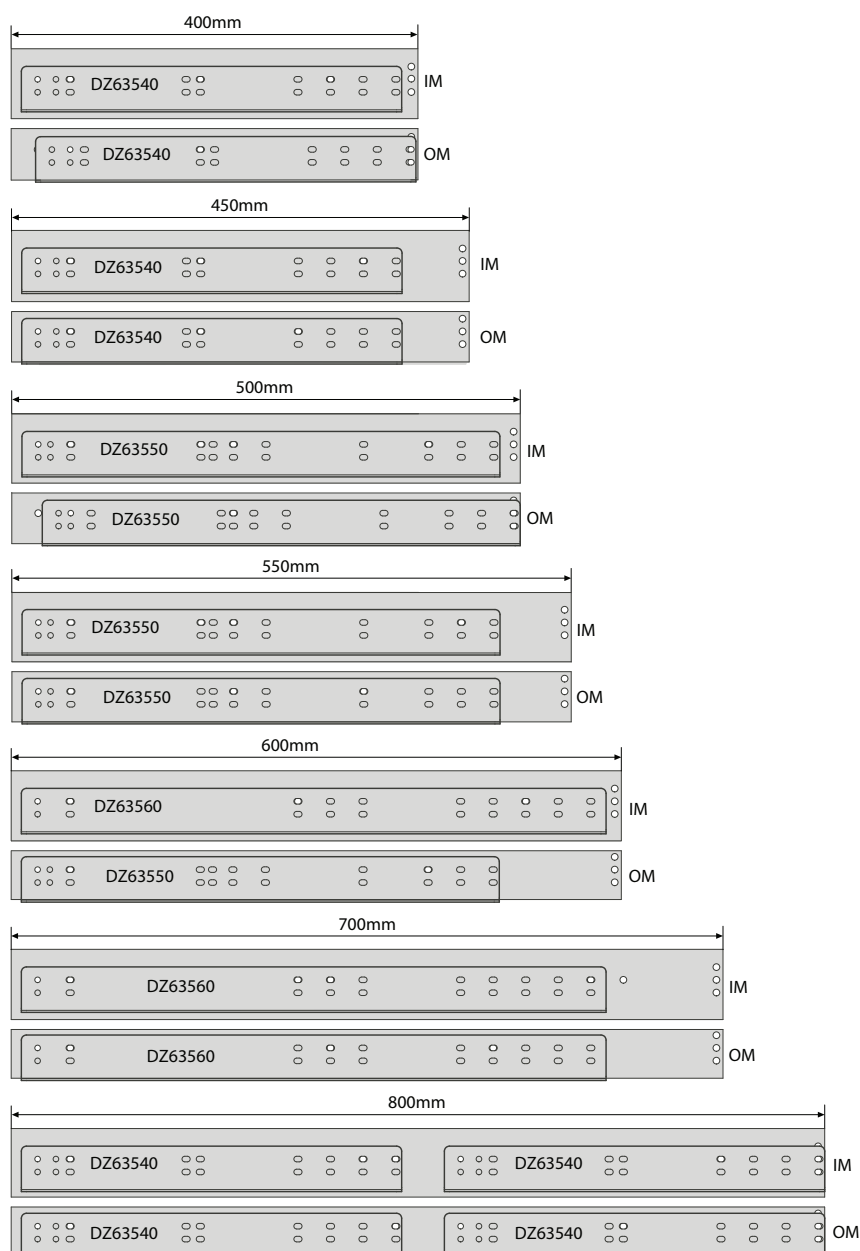

5321

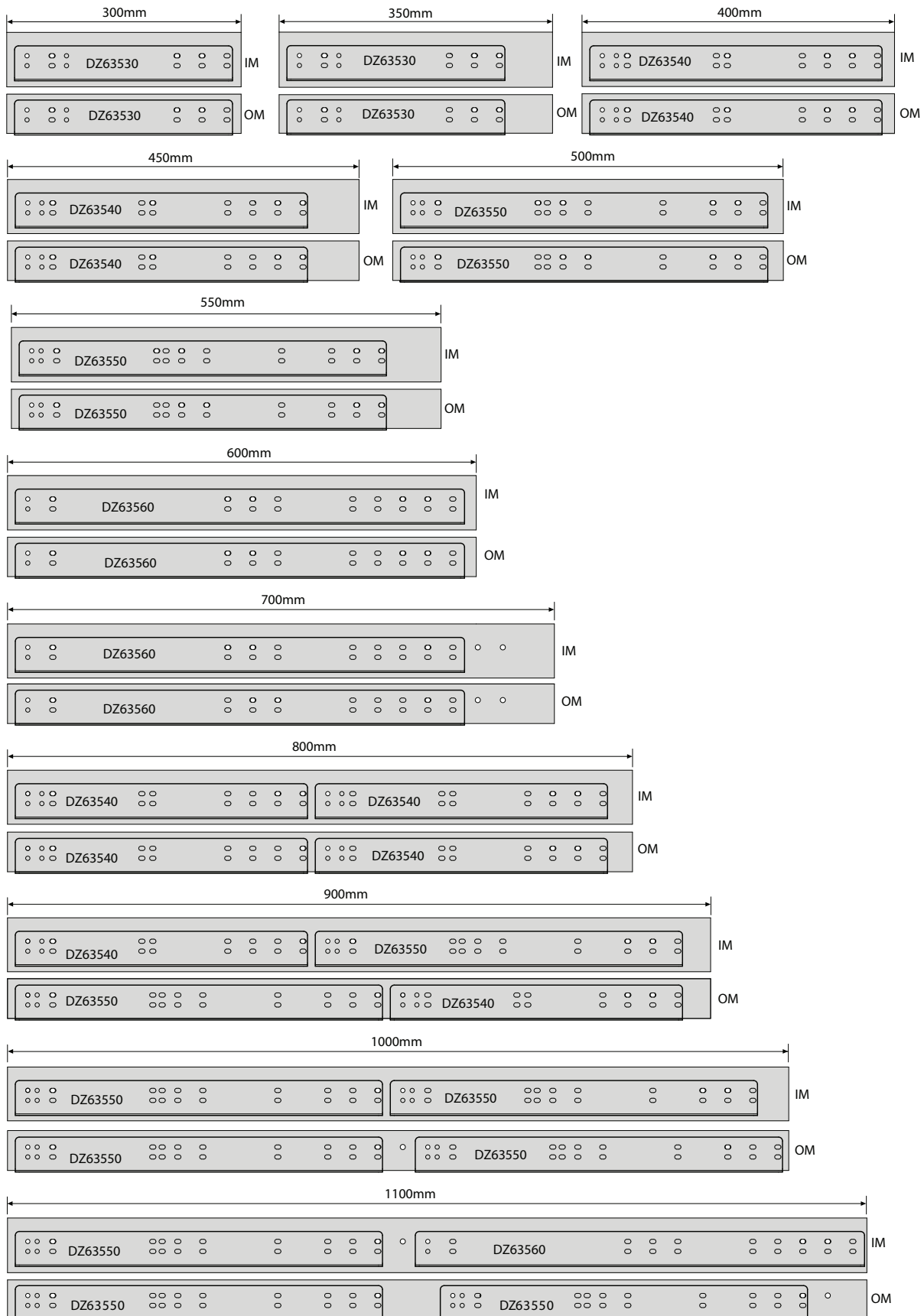



## DZCC11-AD Cable tray

for 3607 / 5321SC / 5321

Material: Galvanized steel, light passivated

Cable guide widths: 72 mm

Weight per unit : 0,93 kg

### Description

- Wide and slim cable management arms
- Opens/closes similar to an accordion
- Suitable for 2 HE and higher
- Simple separation from the chassis

### Advice

- Not suitable for rails exceeding a length of 700 mm.
- Use a minimum of 2 fixation holes at the end of each bracket.



## DZCC5AD Cable tray

for 3607 / 5321SC / 5321

Material: Galvanized steel, light passivated

Cable guide widths: 31 mm

Weight per unit: 0,47 kg

### Description

- Wide and slim cable management arms
- Opens/closes similar to an accordion
- Suitable for 2 HE and higher
- Simple separation from the chassis

### Advice

- Not suitable for rails exceeding the 700 mm length.
- Use a minimum of 2 fixation holes at the end of each angle bracket.



## DZCC11-AD

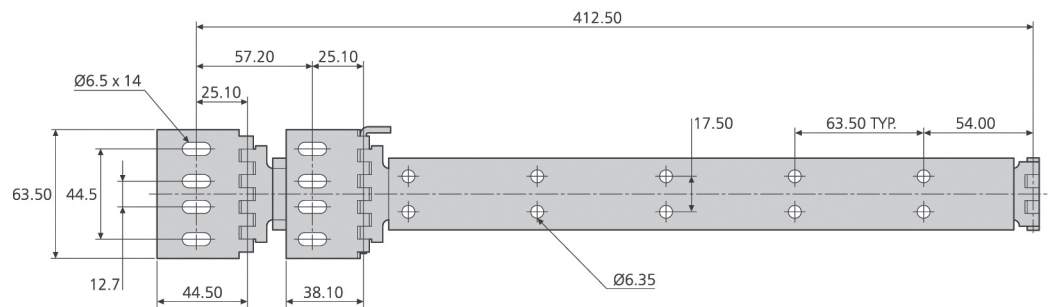
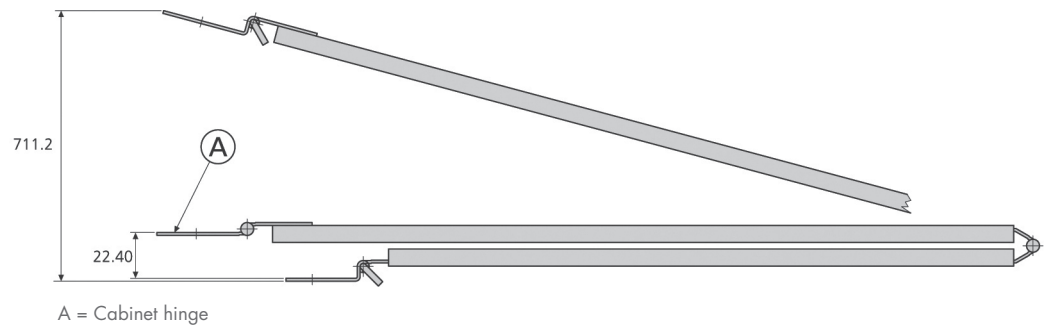

## DZCC5AD

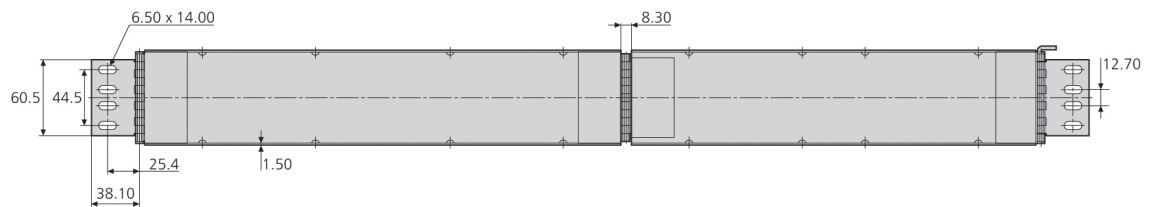
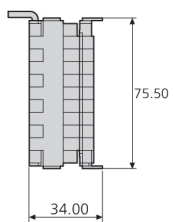
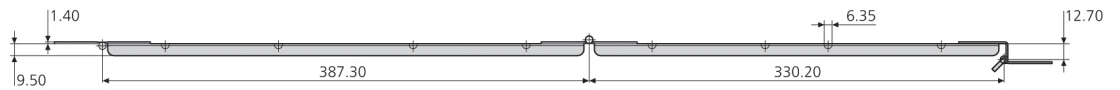

## Mounting brackets

Optional brackets are available to facilitate the mounting process of the rails in an electronic rack/housing

### Advice

- All angle brackets are delivered as complete construction kits with fixation components (without bead nuts).
- Short brackets are generally used at the front of the chassis and long brackets at the back.

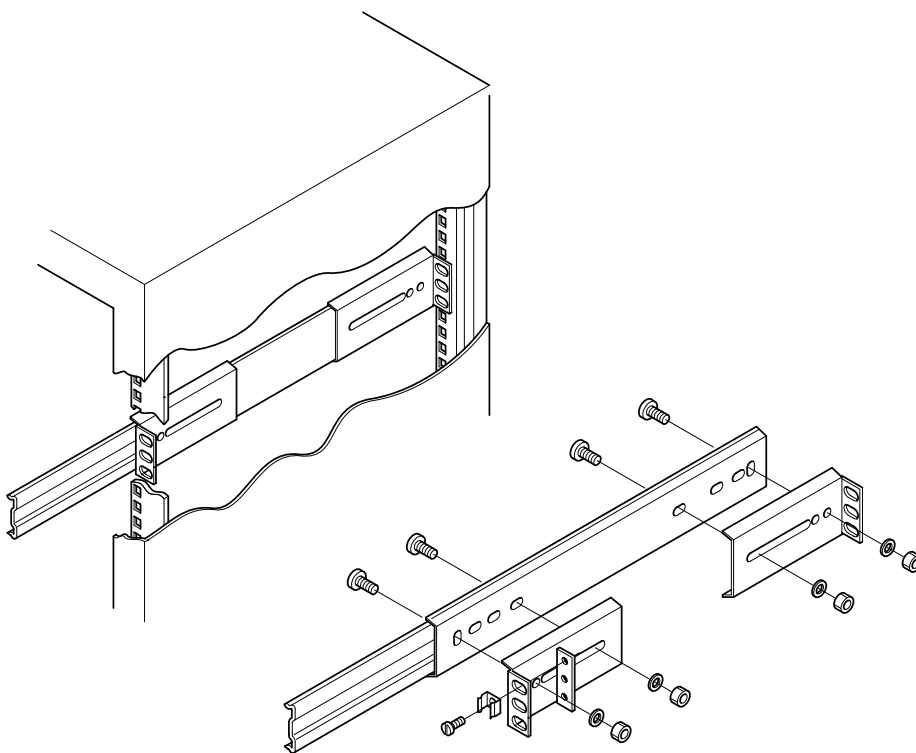

### Direct mounting, general housings

01. Make sure the cabinet sides are parallel to each other and the chassis-sides are parallel and at right angles to the body.
02. Firstly mount the rails on to the beads of the body and then the chassis on to the rails
03. Test the chassis for a balanced movement without jerk.
04. If the rail movement is irregular or gets stuck:
  - » Loosen the screws of the main body and then the ones on the chassis.
  - » Move the unit back and forth a few times.
  - » Once the movement has improved, tighten the screws and move it back and forth again.
  - » If the movement remains irregular, please test the measurements of the body and the chassis.

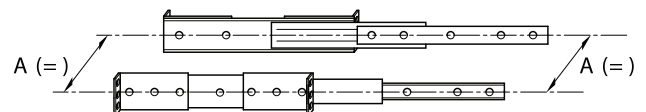
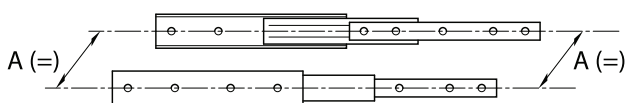
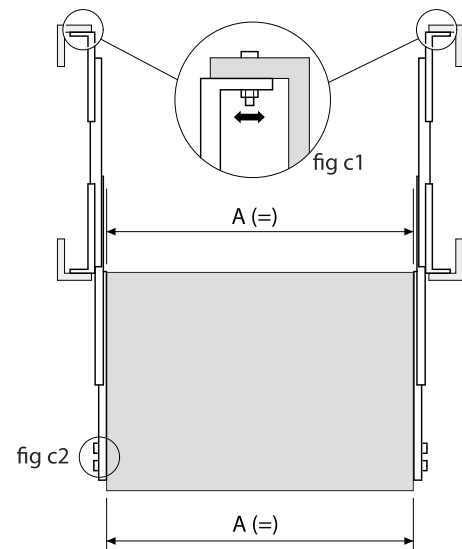
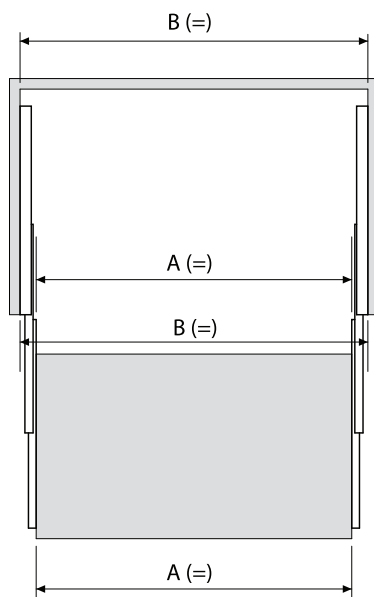

### Mounting of the electronic body on to the trays with Accuride brackets

01. Make sure the cabinet sides are parallel to each other and the chassis-sides are parallel and at right angles to the body.
  02. Using assembly kits and brackets, mount the brackets on to the rail-body components.
  03. Fit the rails into the rack and secure with rod nuts.
  04. Mount the rail on to the chassis
  05. Test the chassis for a balanced movement without jerk.
  06. If the rail movement is irregular or gets stuck:
    - » Loosen the screws at the back of the bracket and reset it (fig. c1)
    - » Loosen the screws of the chassis (fig. c2)
    - » Move the unit back and forth a few times
    - » Once the movement has improved, tighten the screws and move it back and forth again.
- » If the movement remains irregular, please test the measurements of the body and the chassis.

## Bracket DZ63490-4

for 3607 / 5321 / 5321SC

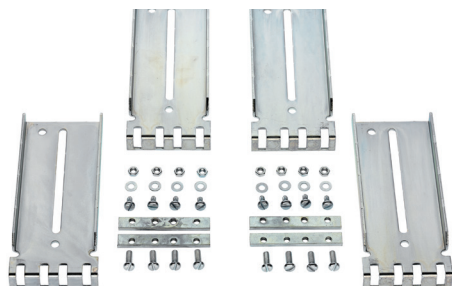

### Advice

- Every unit contains 4 brackets, 4 bead nuts, 8 screws for the bracket, 8 oval head screws.
- Caged nuts are not included in the delivery package

### Brackets

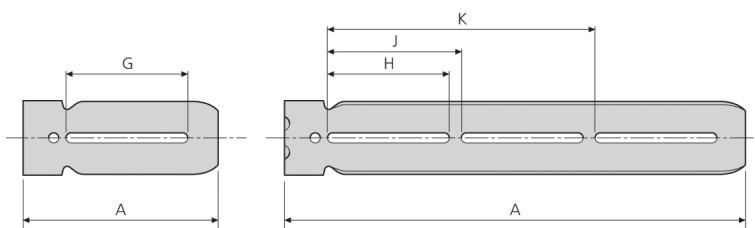

### Bead nuts

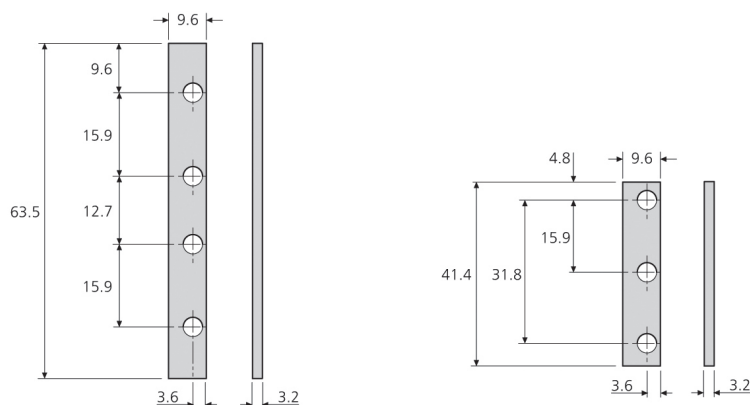

63xxx	Series	A (F) mm	A (R) mm	B (4) mm	B (3) mm	C mm	D mm	E mm	G mm	H mm	J mm	K mm	W kg
DZ65490-4	3607, 5321, 5321SC	140	140,00	60	-	14	5,5	15,9	96	-	-	-	0,75

(F) = Front

(R) = Back

(4) = 4-Hole

(3) = 3-Hole

A large grid of small dots for taking notes, covering the majority of the page.

---

# Milled heavy duty rails

---

» Milled heavy duty rails	54
» Types of rails	55
» Materials	57
» Outline milled heavy duty rails	56
» 3018 load rating up to 140 kg	58
» 3011 load rating up to 145 kg	60
» 4016 load rating up to 225 kg	61
» 7016 load rating up to 275 kg	63
» 4024 load rating up to 340 kg	64
» 5030 load rating up to 400 kg	19
» 7032 load rating up to 660 kg	65
» 8036 load rating up to 720 kg	66
» 9036 load rating up to 850 kg	68
» 10044 load rating up to 1000 kg	69
» 11044 load rating up to 1150 kg	70
» 15038 load rating up to 1500 kg	71
» 14555 load rating up to 2700 kg	72
» 4020 linear guide up to 245 kg	76
» Fittings and fixtures linear guide	77

---

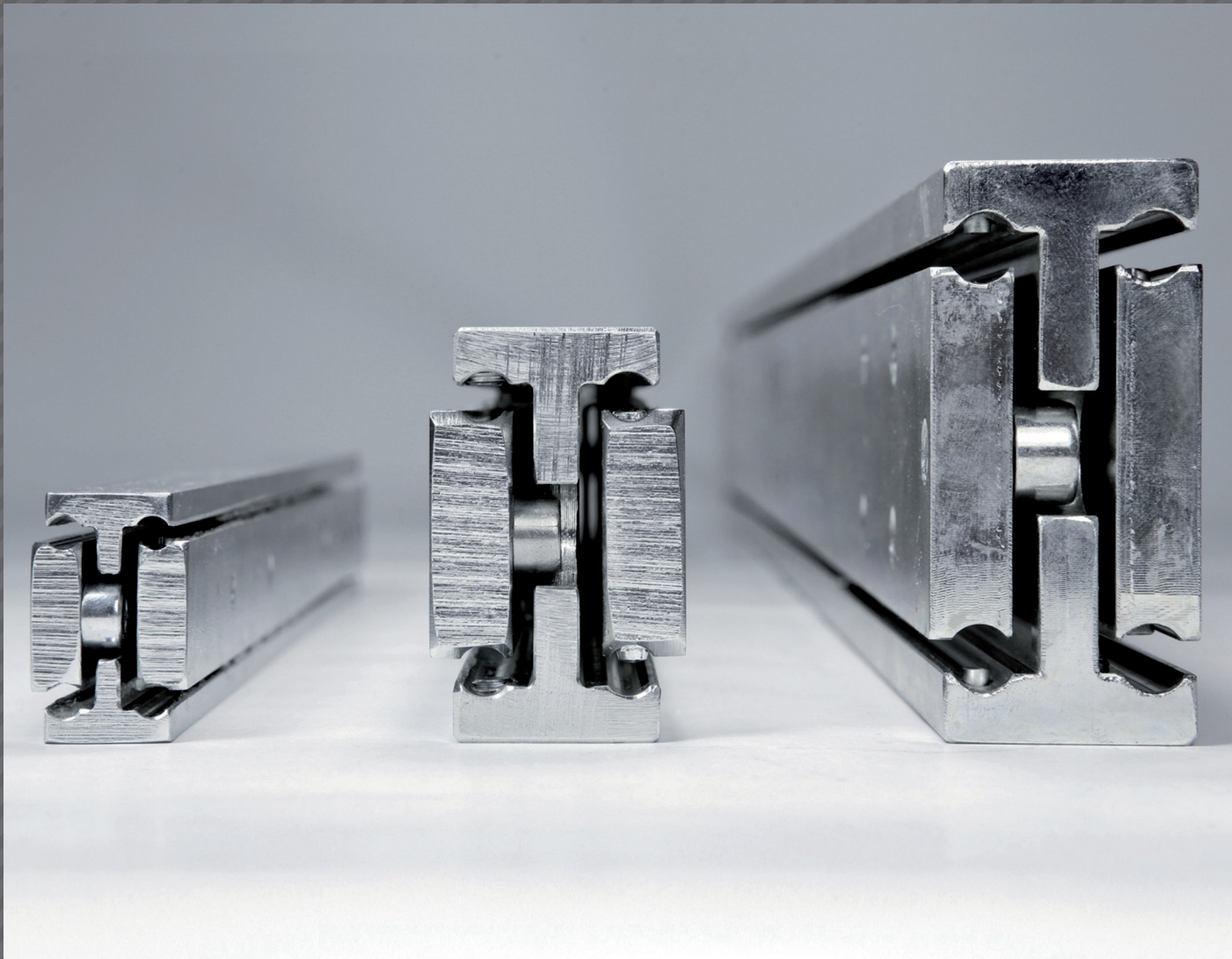

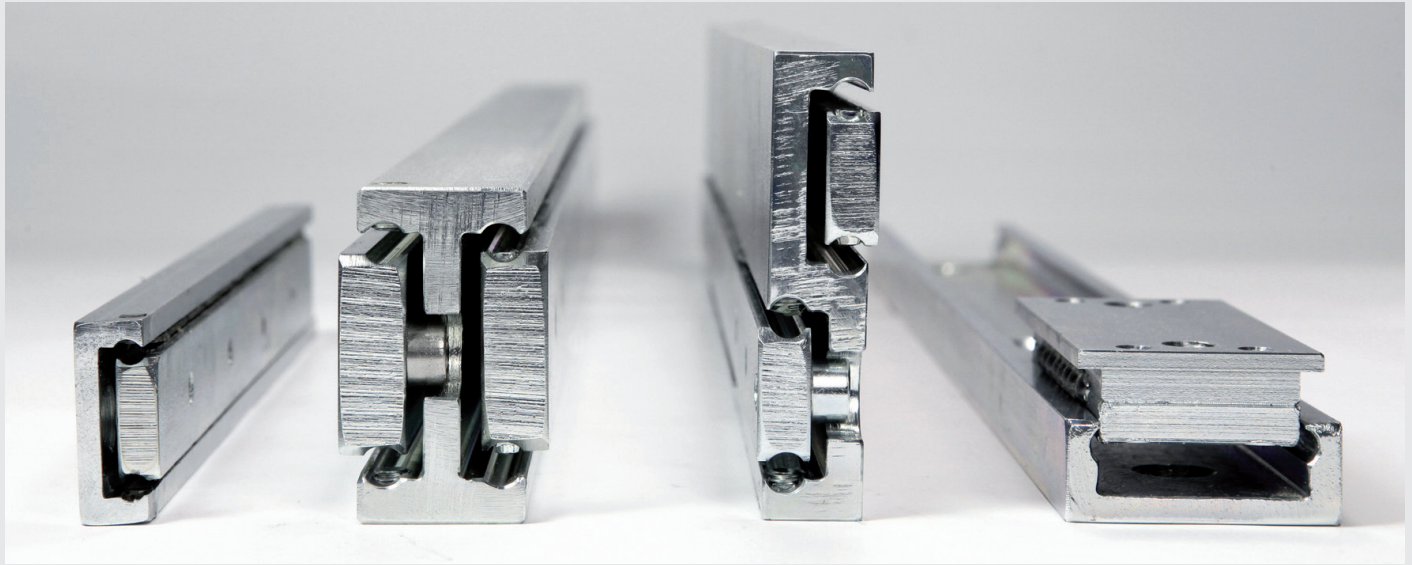

## For numerous industrial practices

Compared to conventional telescopic rails (mainly galvanized, non alloy steel) Leschhorn's heavy duty rails are known for their especially solid structure and high load ratings.

The milled heavy duty-telescopic rails are considerably stronger in resisting side pressures than conventional telescopic rails. Especially here, high pressures affect the ball-bearing movement which is not to be underestimated.

## In-house manufacture

Our in-house production enables us to offer custom-made solutions. Individually adapted designs are especially common for high load ratings. Custom designs specifying length, material and drilling are possible. Depending on the type of rail, we offer a choice of extensions of rail lengths between 300 mm to 3000 mm which are available in steel, stainless steel and aluminium.

## Service & Advice

To meet your individual standards and requirements or for specific questions about load ratings and other queries, our team of experts is happy to help. Do not hesitate to contact us about your individual requirements and we will happily provide an appropriate quote for you.

Phone: 004969 - 420 97 60

### At a glance!

#### Heavy duty rail (per pair in extended position)

Extensions: depending on type, from 300 mm to 3000 mm  
Load ratings: depending on type, from 60 kg to 2.700 kg

#### Linear guides

Gliding length: up to approx. 2.920 mm

## Load rating

- » If not specified otherwise the presented lifting capacities are the highest reachable for a pair of guides mounted laterally with a 1000 mm rail spacing. For bigger spacing please contact our staff first for an individual consultation.
- » The load rating varies depending on the length of the rail. Please find further details on the appropriate data sheets.
- » Wider drawers generally require rails with higher load ratings to withstand stronger side pressures. Our technical support is happy to assist you on this matter.
- » The stated figures refer to the centre point of the drawers in the extended position and are specified in kg.
- » The load ratings shown are static. Leschhorn rails have a static safety factor of 30% in the extended position.
- » Horizontal/flat mounting of the rails decreases the resilience to approx. 30% of the vertical (side) load rating.

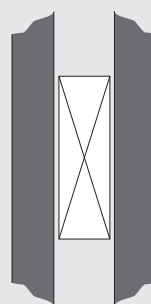

Vertically mounted =  
100% of stated load rating

Horizontally mounted =  
30% of stated load rating

- » The subsidence for horizontally/flat mounted telescopic rails varies depending on its purpose. We recommend the construction of a prototype to assure the subsidence is within acceptable parameters.
- » We further recommend that rails should be tested in its design application.
- » All fixation points are to be used in order to reach the maximum load rating.
- » Appropriate fixation devices must be used.
- » The stated load ratings may not apply for special applications in which the rails are exposed to shock or are operated incorrectly or if frequent access is necessary.



**Example: Calculation of the load rating of a heavy duty rail type 7032**

**Rail length: 1200mm, Full extension.**

The stated lifting capacity P applies under assumption that the load center point is located at the center of the extension (Y/2)

Is the load center point (Y1) located differently please refer to the following formula:

Lifting capacity  $P(Y1) = \frac{1}{2} P Y / Y1$  (but maximum P)

**Example:**

Lifting capacity P = 640 kg, length of extension Y = 1200 mm, Load center point Y1 = 850 mm

**With the result:**

$P(Y1) = \frac{1}{2} P Y / Y1 = \frac{1}{2} \times 640 \text{ kg} \times 1200 / 800 = 480,0 \text{ kg}$

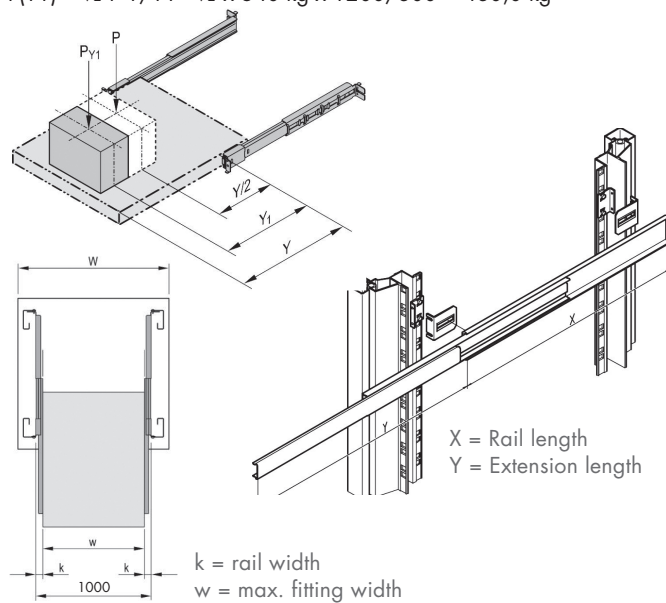

**Calculation of deflection**

- Mb = Bending moment
- W = Axial moment of resistant
- F = Bending force
- L = Length (extension lengths)
- f = Deflection
- sigma b = Bending stress

sigma b = Mb/W  
Mb = F\*L  
W =  $b \cdot h^2 / 6$

Mb = W \* sigma b  
F\*L =  $(b \cdot h^2 / 6) \cdot \text{sigma b}$   
F =  $(b \cdot h^2 / 6) \cdot \text{sigma b} / L$

F = the maximum allowable rate (in newton) the rail can be loaded with! To convert from newton [N] to kg [Kg], divide the rate F by  $g = 9,81 \text{ m/s}^2$ .

**Tray loaded with a single concentrated load, tightened onesided:**

- E = Modulus of elasticity in kN/mm<sup>2</sup>
- I = Moment of area

$I_x = b \cdot h^3 / 12$   
E = 196 ... 216 (Stahl)

$f = \frac{F \cdot l^3}{3 \cdot E \cdot I}$

*The alignment of the mounting affects the rail movement and the load rating. See the following illustrations.*

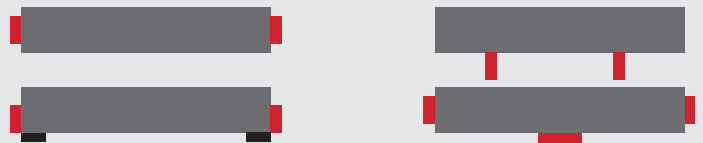

Good

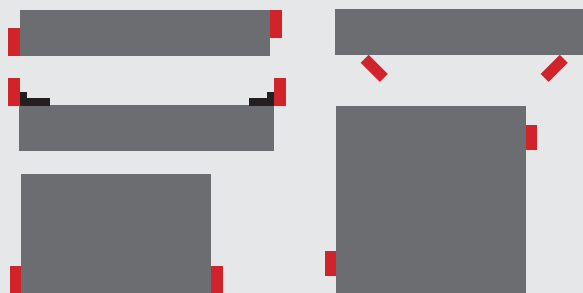

Acceptable

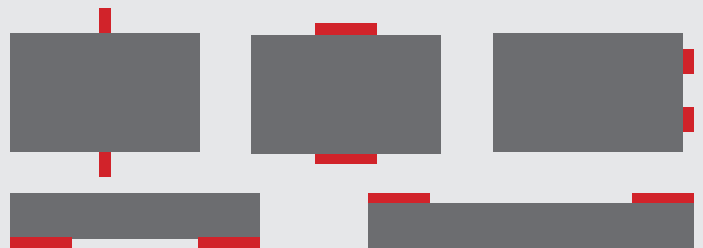

Not to be recommended

## Full extension / Partial extension / Over extension

Extension models are to be chosen depending on stability criteria and the requirements of the installation dimensions.

The extension length of a partial extension is 75% the length of the rail. A full extension allows a pull out of the rail equivalent to the length of the rail. An over extension allows a pull out of the rail further than the length of the rail. Most of Leschhorn's extendable heavy duty rails are available with over extensions on request.

## Extension in both directions

On demand, many rail types are available with an optional passage blocking (cp. table p. 12-13). This special construction enables the mobile rails to be pulled into both directions to create a forward and backward movement.

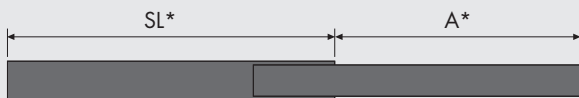

partial extension = length of extension approx. 75 % the length of the rail



full extension = length of extension = the length of the rail

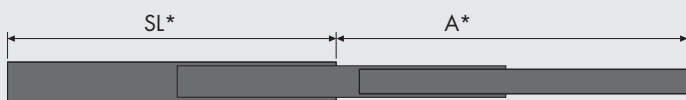

over extension = length of extension = bigger than the length of the rail

\*SL = length of rail, A = length of extension

## Length of the rail (SL)

» The length of the rail equals the maximum length of a fully inserted rail. Rule of thumb: Always use the maximum rail length possible for your purposes.

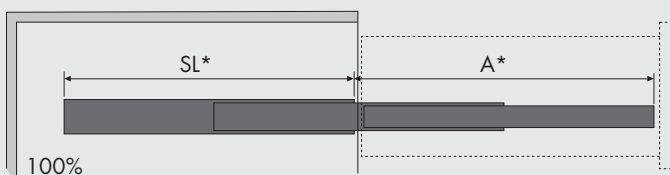
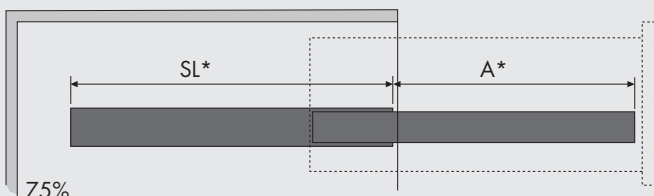

\*SL = length of rail, A = length of extension

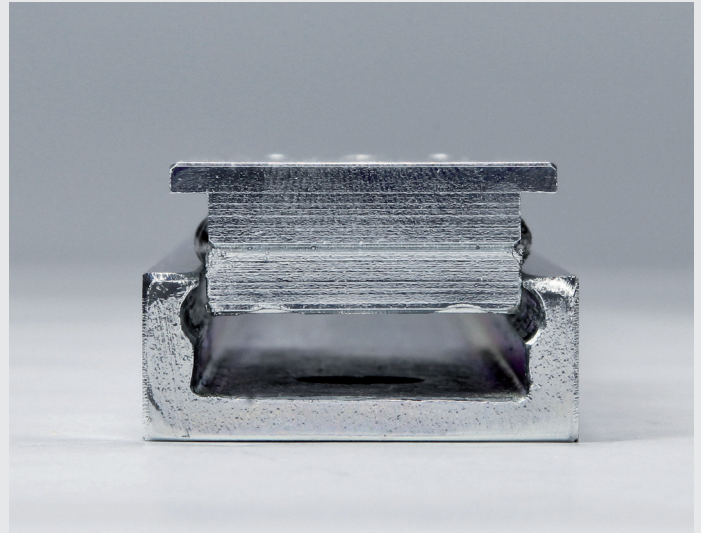

## Installation width

- » The installation width constitutes the space the rail requires between body and drawer.
- » For an optimal performance add +0,2 mm up to +0,5 mm of the rail's nominal thickness. Example: For a rail with a nominal thickness of 30 mm the installation width should be between 30,2 mm and 30,5 mm.
- » Precision rails cannot absorb huge gap aberrations between body and drawer. For optimal rail movement the body and drawer have to be accurate and parallel to each other.

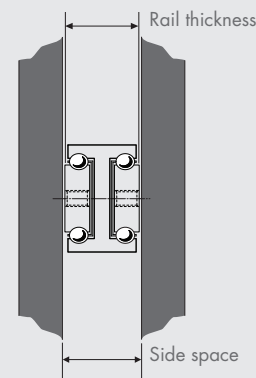

## Optional, customised adaptations

- » Handle – The drawer can be extended after operating a locking system. However, the resistance of the ball cage has to be overcome
- » Lockings keep the rails in the inserted or extended position until a handle is operated.
- » The latch/ engagement stabilises the rail in extended and closed position until additional pressure is applied to open or close it.
- » Self-closing with external drive slows down the opening and closing process and creates an optimal and smooth rail movement.
- » Mounting options are for example bayonet insertions or mounting angles

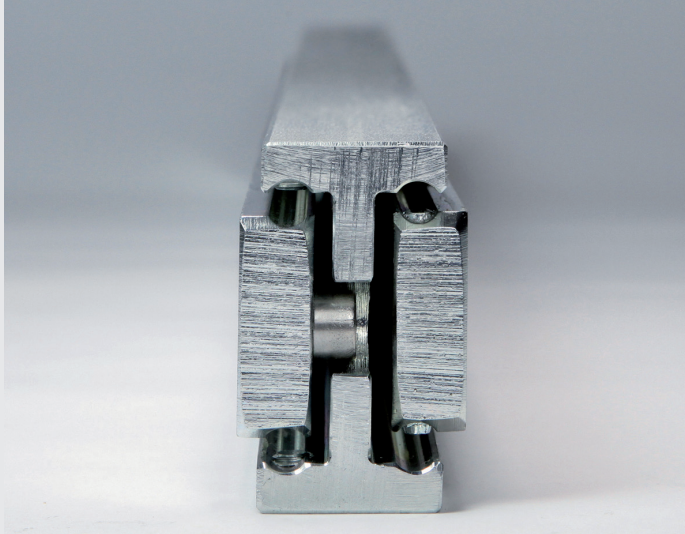

## Quality in all components – The materials used

All products used for Leschhorn's heavy duty rails are exclusively tested and of highest quality. The rails are manufactured to withstand heavy loads and high pressures in order to provide maximal safety.

The standard type of steel we use is zinc coated C45. There is a further choice between V2A or V4A. These materials are generally sufficient enough for most purposes. However, we also offer high quality aluminium rails on your request.

### Stainless steel item no. 1.4301 (X5CrNi18-10), AISI 304 (V2A)

#### Description:

An austenitic and acid resistant 18/10 Cr-Ni-steel, whose polycrystalline texture remains consistent after being sanded using thicknesses of up to 5 mm without any supplementary heat treatment. It is suitable for temperature loads of up to 600 degree Celsius. For even higher temperature loads titanium stabilised steel (item no. 1.4841) should be used.

The weld potential remains fine after several electrical procedures. Oxyacetylene welding should not be performed though. Besides a good polish potential the steel also features a great flexibility for deepdrawing, edge bending, roll forming etc. In the chipping process the steel tends to become brittle, it is therefore necessary to use tools made from high-alloy high speed steel or carbide tools.

#### Usage:

The steel is resistant to water, steam, humidity, food acids as well as light organic and inorganic acids and is suitable for use in various areas and industries such as the food industry, beverage production, pharmaceuticals and cosmetics industry, chemical apparatus engineering, architecture, vehicle manufacture, household articles and devices, surgical instruments, interior design and kitchen fittings, for sanitary facilities, jewellery and works of art.

The resistance to corrosion increases through electro polish, which is especially required by the pharmaceutical and food industry, in medicine and for facade engineering. However, Cr-Ni steel is not suitable for use in swimming pools (q.v. stress corrosion cracking).

### Stainless steel item no. 1.4571 (X6CrNiMo17-12-2), AISI 316 (V4A)

#### Description:

According to all popular welding processes it has a good weldability. A heat treatment after the welding process is usually not necessary. In special cases a heat treatment can be advisable, eg. if the release of welding stress seems necessary for reasons of chemical corrosion. An appropriate heat treatment could be 1/2 hour at 900 °C.

Good ductility. For this type of steel, similar to 1.4541 only well sanded tools should be used for metal-cutting processes. Both types of steel are polishable. The influence of very strong titanium carbides in the mechanical sanding process can however cause grooves in the surface by titanium carbide particles being pulled out and swept across the surface. The grooves are not yet visible until the electropolishing process is completed due to sanding dust covering the surface. This surface structure is in most cases unsuitable for the use in pharmaceutical plant engineering and construction.

#### Usage:

The increased resistance against general and localised corrosion predisposes this steel type for an especially wide range of applications in the field of chemical apparatus engineering.

#### More areas of application:

Further areas of application are nuclear energy, vacuum technology, reactor construction, ship building, furnace construction, sulfites and trans sulfites, cellulose, textile-, dyes-, fatty acid-, photochemical- and the pharmaceutical industries. This material is also increasingly used in the field of emission control.

## Lubricants

Leschhorn's telescopic heavy duty rails can be used in temperature dimensions of -30°C up to +200°C without the necessity of lubrication. Please speak to our technical support first should you intend to use rails in even higher temperature dimensions.

All heavy duty rails we deliver are lubricated with low temperature lubricants enabling them to be used frequently within temperature dimensions of approx. -20°C up to +110°C. Please consider that extreme high temperatures can also have a damaging effect on the lubricant.

## Environment of application

Leschhorn's milled heavy duty rails are created to be used in closed indoor spaces and should be protected from excessive humidity, chemical steam, dirt and corrosion.







The self-cleaning ball cages guarantee an undisturbed and maintenance free movement of the rail by preventing access to the ball storage by foreign particles. Additionally a lubricant is used with an equal durability to the rail when used under normal conditions. However, should cleaning of the rails still be necessary, it is recommended to lubricate the rails after the cleaning process with a high quality lubricant with extremely high compressional strength.

Leschhorn rails manufactured in Germany do not contain any of the following, from EU directives specified dangerous materials: From 2000/53/EG over end-of-life vehicles (27.06.02), 2002/95/EG to the restriction of usage of particular dangerous materials in electro- and electronic devices (27.01.03), 2002/96/EG and electro- and electronic end-of-life devices (27.01.03).

# Outline milled heavy duty rails

Type	Description	max. Loading rate kg	Profile H x B mm	Extension				Material**			Page
				Full-	Partial-	Over-*	in both directions	SteelC45 zinc coated	Stainless steel	Aluminium	
3018	 milled heavy duty rails, T-Profile, Load per pair in extended position	140	30 x 18	✓		✓	✓	✓	✓	✓	60
3011	 milled heavy duty rails, C-Profile, Load per pair in extended position	145	30 x 11		✓			✓	✓	✓	61
4016	 milled heavy duty rails, C-Profile, Load per pair in extended position	225	40 x 16		✓			✓	✓	✓	62
7016	 milled heavy duty rails, S-Profile, Load per pair in extended position	275	70 x 16	✓		✓		✓	✓	✓	63
4024	 milled heavy duty rails, T-Profile, Load per pair in extended position	340	40 x 24	✓		✓	✓	✓	✓	✓	64
5030	 milled heavy duty rails, T-Profile, Load per pair in extended position	400	50 x 30	✓		✓	✓	✓	✓	✓	65
7032	 gefräste Schwerlastschiene, T-Profil, Belastung pro Paar in ausgezogener Position	660	70 x 32	✓		✓	✓	✓	✓	✓	66

\* Over extension only available on request \*\* Advise on material p. 57

Type	Description	max. Load rating kg	Profile H x B mm	Extension				Material**			Page
				Full-	Partial-	Over-*	in both directions	Steel C45 zinc coated	Stainless steel	Aluminium	
8036	 milled heavy duty rails, C-Profile, Load per pair in extended position	720	80 x 36	✓		✓	✓	✓	✓	✓	68
9036	 milled heavy duty rails, T-Profile, Load per pair in extended position	850	90 x 36	✓		✓	✓	✓	✓	✓	69
10044	 milled heavy duty rails, T-Profile, Load per pair in extended position	1000	100 x 44	✓		✓	✓	✓	✓	✓	70
11044	 milled heavy duty rails, T-Profile, Load per pair in extended position	1150	110 x 44	✓		✓	✓	✓	✓	✓	71
15038	 milled heavy duty rails, S-Profile, Load per pair in extended position	1500	150 x 38	✓		✓	✓	✓	✓	✓	72
14555	 milled heavy duty rails, T-Profile, Load per pair in extended position	2700	145 x 55	✓		✓	✓	✓	✓	✓	74
4020	 gefräste Linearführung mit einem Wagen, U-Profil, Wagen einzeln bestellbar, Schienenlänge variabel verfügbar von 300-3000 mm	245	20 x 40					✓	✓	✓	76

\* Over extension only available on request \*\* Advise on material p. 57

## 3018



**Material**  
Steel C45 zinc coated,  
stainless steel or aluminium

**Load rating**  
Up to 140 kg

**Extension**  
Full extension

**Profile**  
H = 30 mm, B = 18 mm

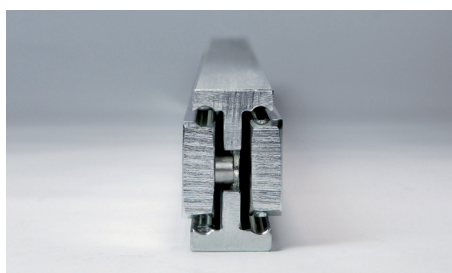

Optional extension in both directions

**Description**

- Length of the rail = length of extension
- Load per pair in extended position, balanced weight distribution and vertical rail structure.
- High resilience and little space requirements

**Advice**

- Appropriate to the applicable length the fixation is carried out with either four or six centrally positioned M6 threaded holes.
- Forward and backward movement is possible with an optional process locking.
- Custom-made products are possible due to our in-house production. (length, pattern of drilling).



- For more information refer to page 54–57.

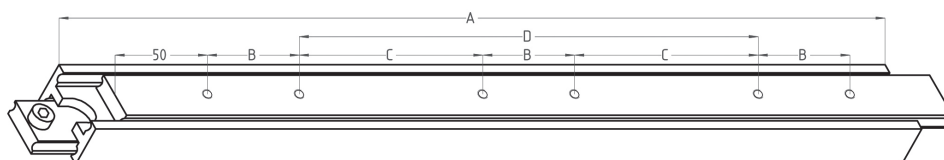
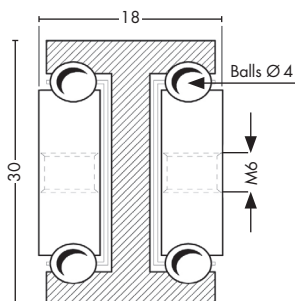

3018*	A**	B	C	D	W***	L****
	mm	mm	mm	mm	kg	kg
3018 - 30	300	50	-	100	0,90	120
3018 - 35	350	50	-	150	1,05	120
3018 - 40	400	50	-	200	1,20	125
3018 - 45	450	50	-	250	1,35	130
3018 - 50	500	50	-	300	1,50	135
3018 - 55	550	50	150	-	1,65	140
3018 - 60	600	50	175	-	1,81	140
3018 - 65	650	50	200	-	1,96	135
3018 - 70	700	50	225	-	2,11	130
3018 - 75	750	50	250	-	2,26	125
3018 - 80	800	50	275	-	2,41	120
3018 - 85	850	50	300	-	2,93	115
3018 - 90	900	50	325	-	2,85	110
3018 - 95	950	50	350	-	3,00	105
3018 - 100	1000	50	375	-	3,19	100

\* Consider prefix when ordering. ST = Steel C45 zinc coated, NI = NIROSTA Stainless steel, AL = Aluminium  
 \*\*\* Weight per unit \*\*\*\* Load rating per rail pair

\*\* A = Length of the rail in inserted position

### Description

- Half the rail length = length of extension
- Load per pair in extended position, balanced weight distribution and vertical rail structure.
- High resilience and little space requirements

### Advice

- Appropriate to the applicable length the fixation is carried out with either two or three countersunk head screws M6 positioned in the centre of the U-profile.
- Horizontal rail structures are possible
- Custom-made products are possible due to our in-house production. (length, pattern of drilling).



- For more information refer to page 54-57.

## 3011

### Material

Steel C45 zinc covered,  
stainless steel or aluminium

### Load rating

Up to 145 kg

### Extension

Partial extension

### Profile

H = 30 mm, B = 11 mm

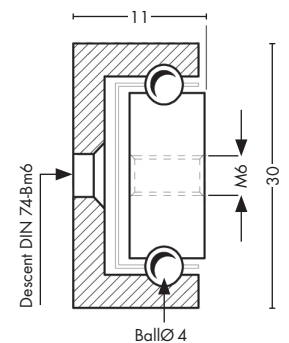
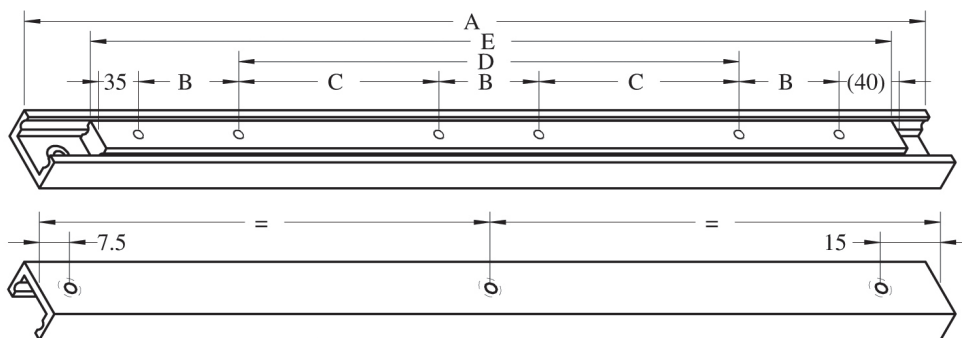
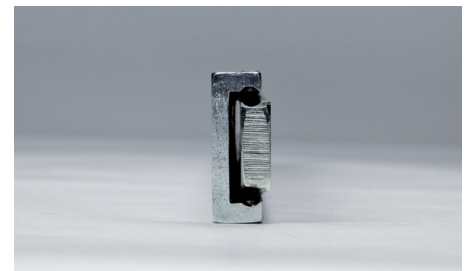

3011*	A**	B	C	D	E	W***	L****
	mm	mm	mm	mm	mm	kg	kg
3011 - 25	250	50	-	50	225	0,71	145
3011 - 30	300	50	-	100	275	0,85	140
3011 - 35	350	50	-	150	325	0,99	135
3011 - 40	400	50	-	200	375	1,13	130
3011 - 45	450	50	-	250	425	1,27	120
3011 - 50	500	50	125	-	475	1,42	115
3011 - 55	550	50	150	-	525	1,56	110
3011 - 60	600	50	175	-	575	1,70	105
3011 - 65	650	50	200	-	625	1,84	100
3011 - 70	700	50	225	-	675	1,98	95
3011 - 75	750	50	250	-	725	2,12	90
3011 - 80	800	50	275	-	775	2,27	85
3011 - 85	850	50	300	-	825	2,41	80
3011 - 90	900	50	325	-	875	2,55	75
3011 - 95	950	50	350	-	925	2,69	70
3011 - 100	1000	50	375	-	975	2,83	60

\* Consider prefix when ordering. ST = Steel C45 zinc covered, NI = NIROSTA Stainless steel, AL = Aluminium

\*\*\* Weight per item \*\*\*\*Load rating per rail pair

\*\* A = Length of the rail in inserted position



## 4016

**Material**  
Steel C45 zinc coated,  
stainless steel or aluminium

**Load rating**  
Up to 225 kg

**Extension**  
Partial extension

**Profile**  
H = 40 mm, B = 16 mm

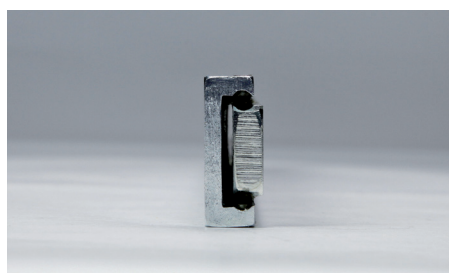

### Description

- Half the rail length = length of extension
- Load per pair in extended position, balanced weight distribution and vertical rail structure.
- High resilience and little space requirements

### Advice

- Appropriate to the applicable length the fixation is carried out with either two or three countersunk head screws M6 positioned in the centre of the U-profile.
- Horizontal rail structures are possible
- Custom-made products are possible due to our in-house production. (length, pattern of drilling).



- For more information refer to page 54–57.

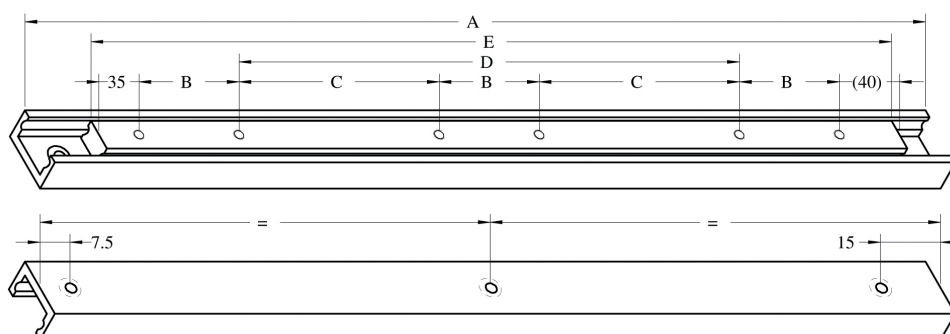
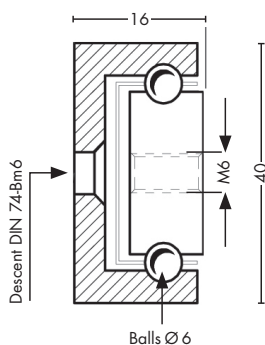

4016*	A**	B	C	D	E	W***	L****
	mm	mm	mm	mm	mm	kg	kg
4016 - 30	300	50	-	100	275	1,49	225
4016 - 35	350	50	-	150	325	1,73	220
4016 - 40	400	50	-	200	375	1,98	215
4016 - 45	450	50	-	250	425	2,23	210
4016 - 50	500	50	125	-	475	2,48	200
4016 - 55	550	50	150	-	525	2,73	190
4016 - 60	600	50	175	-	575	2,97	190
4016 - 65	650	50	200	-	625	3,22	185
4016 - 70	700	50	225	-	675	3,47	180
4016 - 75	750	50	250	-	725	3,72	175
4016 - 80	800	50	275	-	775	3,96	175
4016 - 85	850	50	300	-	825	4,21	170
4016 - 90	900	50	325	-	875	4,46	170
4016 - 95	950	50	350	-	925	4,71	165
4016 - 100	1000	50	375	-	975	4,96	155
4016 - 105	1050	50	400	-	1025	5,20	150
4016 - 110	1100	50	425	-	1075	5,45	145
4016 - 115	1150	50	450	-	1125	5,70	140
4016 - 120	1200	50	475	-	1175	5,95	140

\* Consider prefix when ordering. ST = Steel C45 zinc coated, NI = NIROSTA Stainless steel, AL = Aluminium  
\*\*\* Weight per unit \*\*\*\* Load rating per rail pair

\*\* A = Length of the rail in inserted position



### Description

- Length of the rail = Extension
- Load per pair in extended position, balanced weight distribution and vertical rail structure.
- High resilience and little space requirements

### Advice

- Appropriate to the applicable length the fixation is carried out with either four or six centrally positioned M6 threaded holes.
- Custom-made products are possible due to our in-house production. (length, pattern of drilling).



- For more information refer to page 54–57.

## 7016

### Material

Steel C45 zinc coated,  
stainless steel or aluminium

### Load rating

Up to 275 kg

### Extension

Full extension

### Profile

H = 70, B = 16 mm

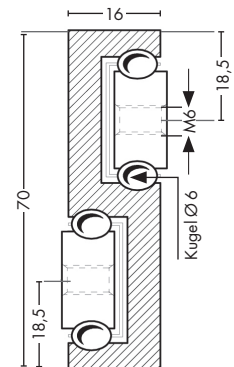
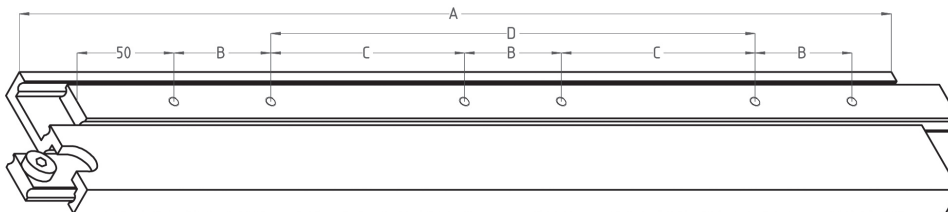
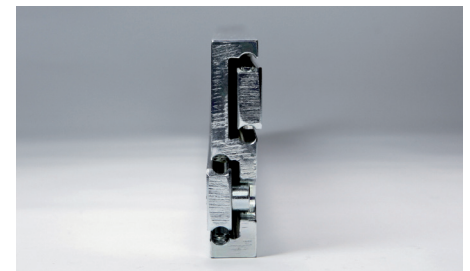

7016*	A**	B	C	D	W***	L****
	mm	mm	mm	mm	kg	kg
7016 - 30	300	50	-	100	2,69	275
7016 - 35	350	50	-	150	3,14	270
7016 - 40	400	50	-	200	3,58	265
7016 - 45	450	50	-	250	4,03	260
7016 - 50	500	50	125	-	4,48	255
7016 - 55	550	50	150	-	4,93	240
7016 - 60	600	50	175	-	5,38	235
7016 - 65	650	50	200	-	5,82	230
7016 - 70	700	50	225	-	6,27	225
7016 - 75	750	50	250	-	6,72	220
7016 - 80	800	50	275	-	7,17	210
7016 - 85	850	50	300	-	7,62	195
7016 - 90	900	50	325	-	8,06	185
7016 - 95	950	50	350	-	8,51	170
7016 - 100	1000	50	375	-	8,96	160

\* Consider prefix when ordering. ST = Steel C45 zinc coated, NI = NIROSTA Stainless steel, AL = Aluminium  
 \*\*\* Weight per unit \*\*\*\* Load rating per rail pair

\*\* A = Length of the rail in inserted position

## 4024



**Material**  
Steel C45 zinc coated,  
Stainless steel or aluminium

**Load rating**  
Up to 340 kg

**Extension**  
Full extension

**Profile**  
H = 40 mm, B = 24 mm

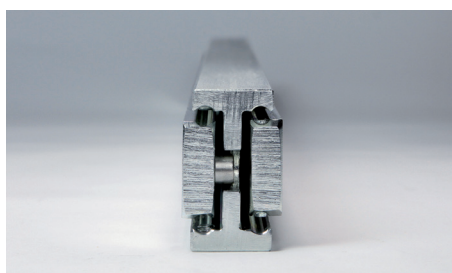

Optional extension in both directions

### Description

- Rail length = length of extension
- Load per pair in extended position, balanced weight distribution and vertical rail structure.
- High resilience and little space requirements

### Advice

- Appropriate to the applicable length the fixation is carried out with either four or six centrally positioned M6 threaded holes.
- Forward and backward movement is possible with an optional process locking.
- Custom-made products are possible due to our in-house production. (length, pattern of drilling).



- For more information refer to page 54–57

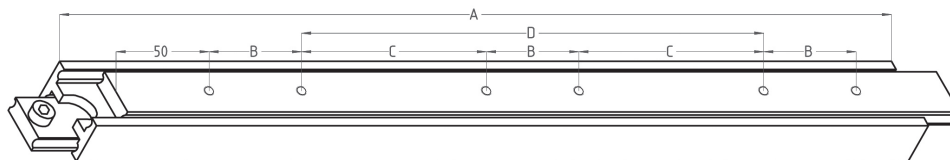
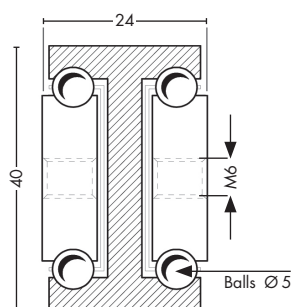

4024*	A**	B	C	D	W***	L****
	mm	mm	mm	mm	kg	kg
4024 - 30	300	50	-	100	1,70	240
4024 - 35	350	50	-	150	1,98	260
4024 - 40	400	50	-	200	2,27	280
4024 - 45	450	50	-	250	2,55	300
4024 - 50	500	50	-	300	2,83	310
4024 - 55	550	50	150	-	3,12	330
4024 - 60	600	50	175	-	3,40	340
4024 - 65	650	50	200	-	3,68	340
4024 - 70	700	50	225	-	3,96	330
4024 - 75	750	50	250	-	4,25	325
4024 - 80	800	50	275	-	4,53	320
4024 - 85	850	50	300	-	4,81	315
4024 - 90	900	50	325	-	5,10	310
4024 - 95	950	50	350	-	5,38	305
4024 - 100	1000	50	375	-	5,66	300

\* Consider prefix when ordering. ST = Steel C45 zinc coated, NI = NIROSTA Stainless steel, AL = Aluminium

\*\*\* Weight per unit \*\*\*\* Load rating per rail pair

\*\* A = Length of the rail in inserted position

### Description

- Rail length = length of extension
- Load per pair in extended position, balanced weight distribution and vertical rail structure.
- High resilience and little space requirements

### Advice

- Appropriate to the applicable length the fixation is carried out with either four or six centrally positioned M8 threaded holes.
- Forward and backward movement is possible with an optional process locking.
- Custom-made products are possible due to our in-house production. (length, pattern of drilling).



- For more information refer to page 54-57

## 5030

### Material

Steel C45 zinc coated,  
stainless steel or aluminium

### Load rating

Up to 400 kg

### Extension

Full extension

### Profile

H = 50 mm, B = 30 mm

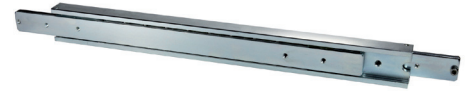

Optional extension in both directions

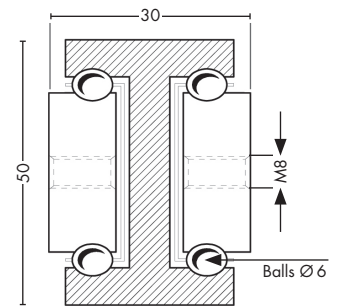
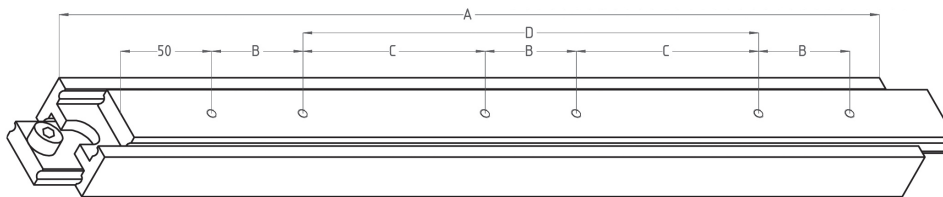
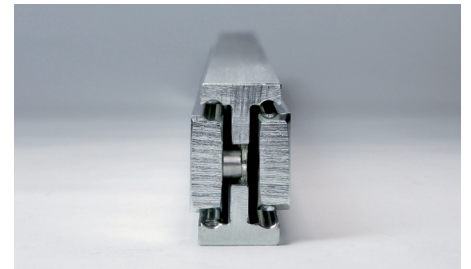

5030*	A**	B	C	D	W***	L****
	mm	mm	mm	mm	kg	kg
5030 - 30	300	50	-	100	2,66	300
5030 - 35	350	50	-	150	3,10	310
5030 - 40	400	50	-	200	3,54	320
5030 - 45	450	50	-	250	3,98	330
5030 - 50	500	50	-	300	4,43	350
5030 - 55	550	50	150	-	4,87	380
5030 - 60	600	50	175	-	5,31	400
5030 - 65	650	50	200	-	5,75	395
5030 - 70	700	50	225	-	6,20	390
5030 - 75	750	50	250	-	6,64	385
5030 - 80	800	50	275	-	7,08	380
5030 - 85	850	50	300	-	7,52	375
5030 - 90	900	50	325	-	7,97	370
5030 - 95	950	50	350	-	8,41	365
5030 - 100	1000	50	375	-	8,85	360
5030 - 105	1050	50	400	-	9,29	355
5030 - 110	1100	50	425	-	9,74	350
5030 - 115	1150	50	450	-	10,18	345
5030 - 120	1200	50	475	-	10,62	340
5030 - 125	1250	50	500	-	11,06	335
5030 - 130	1300	50	525	-	11,51	330
5030 - 135	1350	50	550	-	11,95	325
5030 - 140	1400	50	575	-	12,39	320

\* Consider prefix when ordering. ST = Steel C45 zinc coated, NI = NIROSTA Stainless steel, AL = Aluminium

\*\*\*Weight per unit      \*\*\*\* Load rating per rail pair

\*\* A = Length of the rail in inserted position

## 7032



**Material**  
Steel C45 zinc coated,  
stainless steel or aluminum

**Load rating**  
Up to 660 kg

**Extension**  
Full extension

**Profile**  
H = 70 mm, B = 32 mm

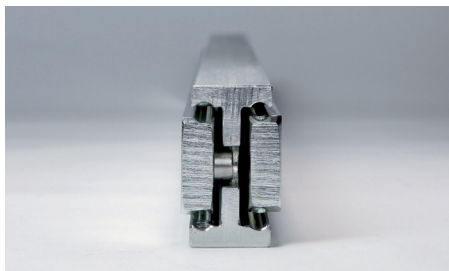

Optional extension in both directions

### Description

- Rail length = length of extension
- Load per pair in extended position, balanced weight distribution and vertical rail structure.
- High resilience and little space requirements

### Advice

- Appropriate to the applicable length the fixation is carried out with either eight or twelve M8 threaded holes.
- The centered drillings are not necessary for a rail structure of up to 600 mm
- Forward and backward movement is possible with an optional process locking.
- Custom-made products are possible due to our in-house production. (length, pattern of drilling).



- For more information refer to page 54–57.

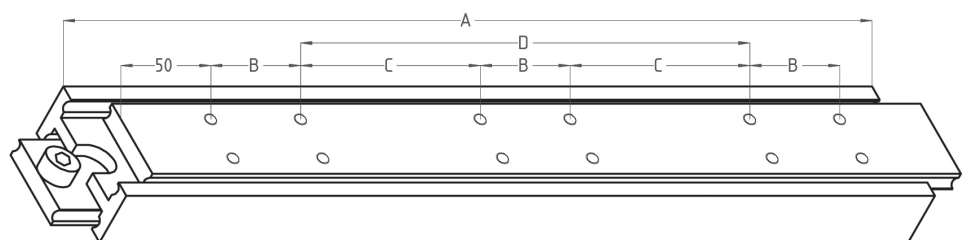
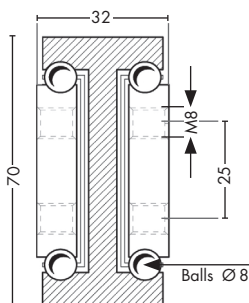

7032*	A** mm	B mm	C mm	D mm	W*** kg	L**** kg
7032 - 40	400	50	-	-	5,29	400
7032 - 45	450	50	-	-	5,95	410
7032 - 50	500	50	-	-	6,61	420
7032 - 55	550	50	-	-	7,27	430
7032 - 60	600	50	-	-	7,93	440
7032 - 65	650	50	200	-	8,59	450
7032 - 70	700	50	225	-	9,25	500
7032 - 75	750	50	250	-	9,91	550
7032 - 80	800	50	275	-	10,57	560
7032 - 85	850	50	300	-	11,23	580
7032 - 90	900	50	325	-	11,89	600
7032 - 95	950	50	350	-	12,56	620
7032 - 100	1000	50	375	-	13,22	650
7032 - 105	1050	50	400	-	13,88	660
7032 - 110	1100	50	425	-	14,54	660
7032 - 115	1150	50	450	-	15,20	650
7032 - 120	1200	50	475	-	15,86	640
7032 - 125	1250	50	500	-	16,52	620
7032 - 130	1300	50	525	-	17,18	600
7032 - 135	1350	50	550	-	17,84	580
7032 - 140	1400	50	575	-	18,50	560
7032 - 145	1450	50	600	-	19,16	540
7032 - 150	1500	50	625	-	19,82	520
7032 - 155	1550	50	650	-	20,48	500
7032 - 160	1600	50	675	-	21,15	480
7032 - 165	1650	50	700	-	21,81	460
7032 - 170	1700	100	650	-	22,47	440
7032 - 175	1750	100	675	-	23,13	420
7032 - 180	1800	100	700	-	23,79	400
7032 - 185	1850	100	725	-	24,45	380
7032 - 190	1900	100	750	-	25,11	360
7032 - 195	1950	100	775	-	25,77	340
7032 - 200	2000	100	800	-	26,43	320

\* Consider prefix when ordering. ST = Steel C45 zinc coated, NI = NIROSTA Stainless steel, AL = Aluminium  
 \*\*\* Weight per unit

\*\* A = Length of the rail in inserted position

\*\*\*\* Load rating per rail pair

## 8036



**Material**  
Steel C45 zinc coated,  
stainless steel or aluminium

**Load rating**  
Up to 720 kg

**Extension**  
Full extension

**Profile**  
H = 80 mm, B = 36 mm

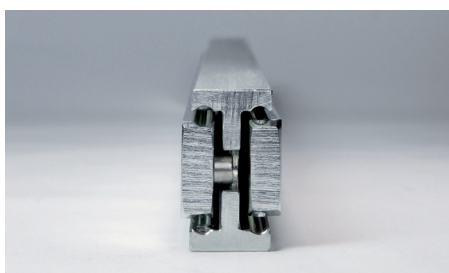

Optional extension in both directions

### Description

- Rail length = length of extension
- Load per pair in extended position, balanced weight distribution and vertical rail structure.
- High resilience and little space requirements

### Advice

- Appropriate to the applicable length the fixation is carried out with twelve M8 threaded holes.
- Forward and backward movement is possible with an optional process locking.
- Custom-made products are possible due to our in-house production. (length, pattern of drilling).



- For more information refer to page 54–57

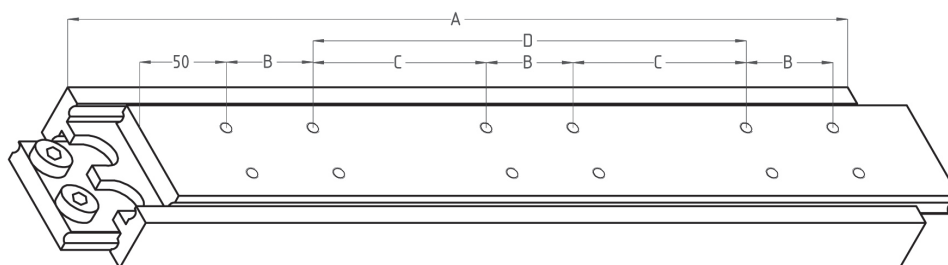
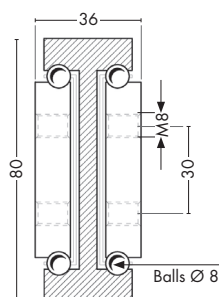

8036*	A**	B	C	D	W***	L****
	mm	mm	mm	mm	kg	kg
8036 - 60	600	50	-	400	39,33	560
8036 - 65	650	50	200	-	10,60	570
8036 - 70	700	50	225	-	11,25	590
8036 - 75	750	50	250	-	12,11	610
8036 - 80	800	50	275	-	13,29	630
8036 - 85	850	50	300	-	13,73	650
8036 - 90	900	50	325	-	14,29	670
8036 - 95	950	50	350	-	15,27	690
8036 - 100	1000	50	375	-	14,12	700
8036 - 105	1050	50	400	-	16,98	720
8036 - 110	1100	50	425	-	17,07	700
8036 - 115	1150	50	450	-	18,77	690
8036 - 120	1200	50	475	-	19,36	670
8036 - 125	1250	50	500	-	20,50	650
8036 - 130	1300	50	525	-	20,98	640
8036 - 135	1350	50	550	-	21,74	630
8036 - 140	1400	50	575	-	22,50	620
8036 - 145	1450	50	600	-	23,16	610
8036 - 150	1500	50	625	-	23,92	590
8036 - 155	1550	50	650	-	24,84	570
8036 - 160	1600	50	675	-	25,69	560
8036 - 165	1650	50	700	-	26,42	540
8036 - 170	1700	100	650	-	27,47	530
8036 - 175	1750	100	675	-	28,45	510
8036 - 180	1800	100	700	-	29,39	490
8036 - 185	1850	100	725	-	29,95	480
8036 - 190	1900	100	750	-	30,62	460
8036 - 195	1950	100	775	-	31,80	440
8036 - 200	2000	100	800	-	32,53	420

\* Consider prefix when ordering. ST = Steel C45 zinc coated, NI = NIROSTA Stainless steel, AL = Aluminium  
 \*\*\* Weight per unit      \*\*\*\* Load rating per rail pair

\*\* A = Length of the rail in inserted position

### Description

- Rail length = length of extension
- Load per pair in extended position, balanced weight distribution and vertical rail structure.

### Advice

- Appropriate to the applicable length the fixation is carried out with twelve M8 threaded holes.
- Forward and backward movement is possible with an optional process locking.
- Custom-made products are possible due to our in-house production. (length, pattern of drilling).



- For more information refer to page 54-57

## 9036

### Material

Steel C45 zinc coated,  
stainless steel or aluminium

### Load rating

Up to 850 kg

### Extension

Full extension

### Profile

H = 90 mm, B = 36 mm



Optional extension in both directions

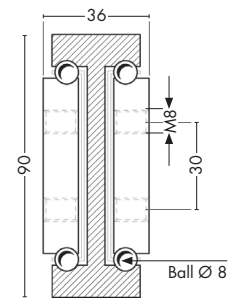
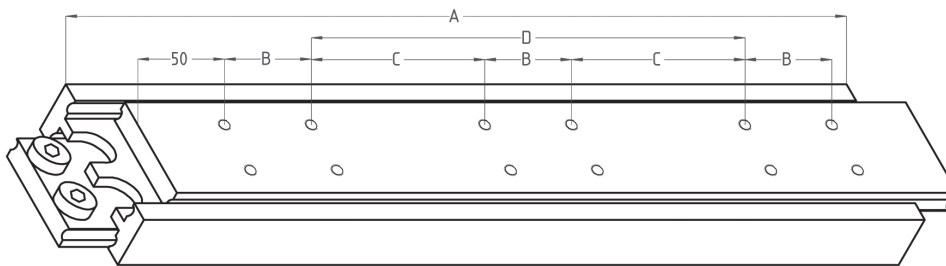
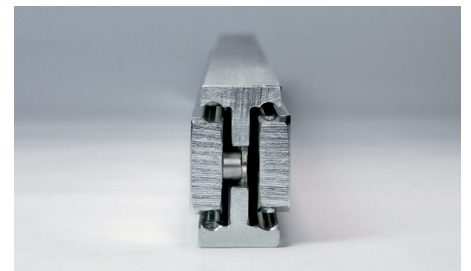

9036*	A**	B	C	D	W***	L****
	mm	mm	mm	mm	kg	kg
9036 - 60	600	50	-	400	11,47	700
9036 - 65	650	50	200	-	12,43	720
9036 - 70	700	50	225	-	13,38	740
9036 - 75	750	50	250	-	14,34	760
9036 - 80	800	50	275	-	15,29	780
9036 - 85	850	50	300	-	16,25	800
9036 - 90	900	50	325	-	17,20	820
9036 - 95	950	50	350	-	18,16	830
9036 - 100	1000	50	375	-	19,12	840
9036 - 105	1050	50	400	-	20,07	850
9036 - 110	1100	50	425	-	21,03	840
9036 - 115	1150	50	450	-	21,98	830
9036 - 120	1200	50	475	-	22,94	820
9036 - 125	1250	50	500	-	23,90	810
9036 - 130	1300	50	525	-	24,85	800
9036 - 135	1350	50	550	-	25,81	790
9036 - 140	1400	50	575	-	26,76	780
9036 - 145	1450	50	600	-	27,72	760
9036 - 150	1500	50	625	-	28,67	740
9036 - 155	1550	50	650	-	29,63	720
9036 - 160	1600	50	675	-	30,59	700
9036 - 165	1650	50	700	-	31,54	680
9036 - 170	1700	100	650	-	32,50	660
9036 - 175	1750	100	675	-	33,45	640
9036 - 180	1800	100	700	-	34,41	620
9036 - 185	1850	100	725	-	35,36	600
9036 - 190	1900	100	750	-	36,32	580
9036 - 195	1950	100	775	-	37,28	560
9036 - 200	2000	100	800	-	38,23	550

\* Consider prefix when ordering. ST = Steel C45 zinc coated, NI = NIROSTA Stainless steel, AL = Aluminium

\*\*\* Weight per unit      \*\*\*\* Load rating per rail pair.

\*\* A = Length of the rail in inserted position

## 10044



**Material**  
Steel C45 zinc coated,  
stainless steel or aluminum

**Load rating**  
Up to 1000 kg

**Extension**  
Full extension

**Profile**  
H = 100 mm, B = 44 mm

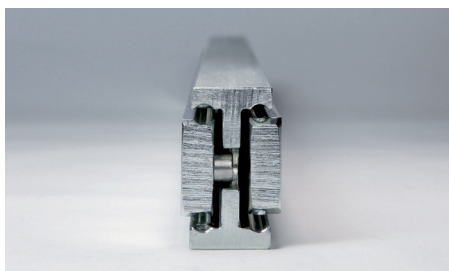

Optional extension in both directions

### Description

- Length of the rail = length of extension
- Load per pair in extended position, balanced weight distribution and vertical rail structure

### Advice

- Appropriate to the applicable length the fixation is carried out with twelve M10 threaded holes.
- Forward and backward movement is possible with an optional process locking.
- Custom-made products are possible due to our in-house production. (length, pattern of drilling).



- For more information refer to page 54-57

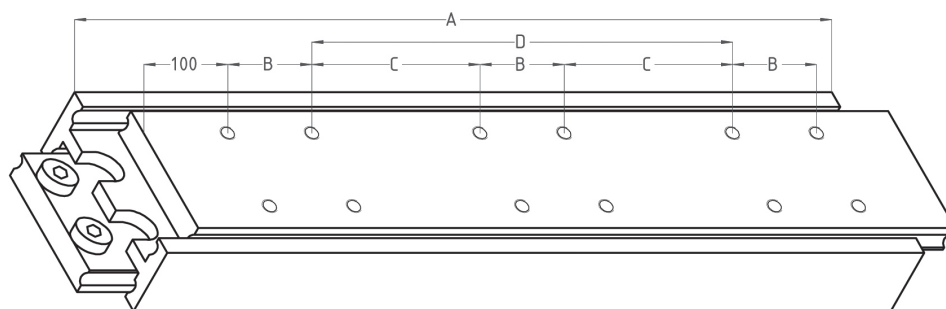
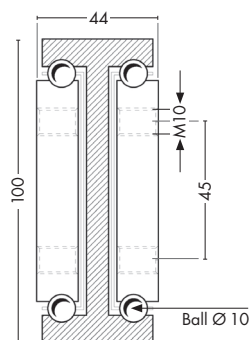

10044*	A** mm	B mm	C mm	D mm	W*** kg	L**** kg
10044 - 80	800	100	150	-	22,84	880
10044 - 85	850	100	175	-	24,27	900
10044 - 90	900	100	200	-	25,70	920
10044 - 95	950	100	225	-	27,13	940
10044 - 100	1000	100	250	-	28,56	960
10044 - 105	1050	100	275	-	29,98	980
10044 - 110	1100	100	300	-	31,41	1000
10044 - 115	1150	100	325	-	32,84	980
10044 - 120	1200	100	350	-	34,27	960
10044 - 125	1250	100	375	-	35,70	940
10044 - 130	1300	100	400	-	37,12	920
10044 - 135	1350	100	425	-	38,55	900
10044 - 140	1400	100	450	-	39,98	880
10044 - 145	1450	100	475	-	41,41	860
10044 - 150	1500	100	500	-	42,83	840
10044 - 155	1550	100	525	-	44,26	820
10044 - 160	1600	100	550	-	45,69	800
10044 - 165	1650	100	575	-	47,12	780
10044 - 170	1700	100	600	-	48,55	760
10044 - 175	1750	100	625	-	49,97	740
10044 - 180	1800	100	650	-	51,40	720
10044 - 185	1850	100	675	-	52,83	700
10044 - 190	1900	100	700	-	54,26	680
10044 - 195	1950	100	725	-	55,68	660
10044 - 200	2000	100	750	-	57,11	650

\* Consider prefix when ordering. ST = Steel C45 zinc coated, NI = NIROSTA Stainless steel, AL = Aluminium  
 \*\*\* Weight per unit      \*\*\*\* Load rating per rail pair

\*\* A = Rail length in inserted position



### Description

- Length of the rail = length of extension
- Load per pair in extended position, balanced weight distribution and vertical rail structure.

### Advice

- Appropriate to the applicable length the fixation is carried out with twelve M10 threaded holes.
- Forward and backward movement is possible with an optional process locking.
- Custom-made products are possible due to our in-house production. (length, pattern of drilling).



- For more information refer to page 54-57

## 11044

### Material

Steel C45 zinc coated,  
stainless steel and aluminium

### Load rating

Up to 1150 kg

### Extension

Full extension

### Profile

H = 110 mm, B = 44 mm



Optional extension in both directions

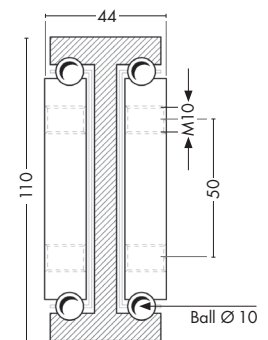
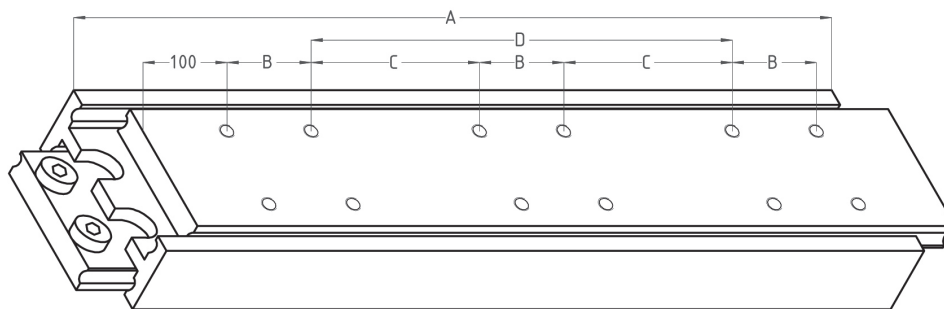
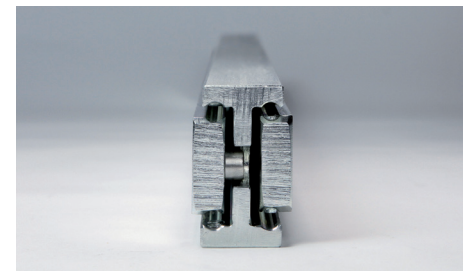

11044*	A** mm	B mm	C mm	D mm	W*** kg	L**** kg
11044 - 80	800	100	150	-	22,84	1020
11044 - 85	850	100	175	-	24,27	1040
11044 - 90	900	100	200	-	25,70	1070
11044 - 95	950	100	225	-	27,13	1100
11044 - 100	1000	100	250	-	28,56	1110
11044 - 105	1050	100	275	-	29,98	1130
11044 - 110	1100	100	300	-	31,41	1150
11044 - 115	1150	100	325	-	32,84	1130
11044 - 120	1200	100	350	-	34,27	1100
11044 - 125	1250	100	375	-	35,70	1090
11044 - 130	1300	100	400	-	37,12	1070
11044 - 135	1350	100	425	-	38,55	1050
11044 - 140	1400	100	450	-	39,98	1030
11044 - 145	1450	100	475	-	41,41	1010
11044 - 150	1500	100	500	-	42,83	990
11044 - 155	1550	100	525	-	44,26	970
11044 - 160	1600	100	550	-	45,69	950
11044 - 165	1650	100	575	-	47,12	930
11044 - 170	1700	100	600	-	48,55	910
11044 - 175	1750	100	625	-	49,97	890
11044 - 180	1800	100	650	-	51,40	870
11044 - 185	1850	100	675	-	52,83	850
11044 - 190	1900	100	700	-	54,26	830
11044 - 195	1950	100	725	-	55,68	800
11044 - 200	2000	100	750	-	57,11	770

\* Consider prefix when ordering. ST = Steel C45 zinc coated, NI = NIROSTA Stainless steel, AL = Aluminium  
 \*\*\* Weight per unit \*\*\*\* Load rating per rail pair

\*\* A = Length of the rail in inserted position

## 15038



**Material**  
Steel C45 zinc coated,  
stainless steel and aluminum

**Load rating**  
Up to 1500 kg

**Extension**  
Full extension

**Profile**  
H = 150 mm, B = 38 mm

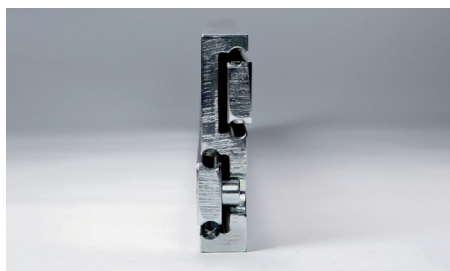

### Description

- Length of the rail = length of extension
- Load per pair in extended position, balanced weight distribution and vertical rail structure
- High resilience and little space requirements

### Advice

- Appropriate to the applicable length the fixation is carried out with either four or six centrally positioned M10 threaded holes.
- Custom-made products are possible due to our in-house production. (length, pattern of drilling).



- For more information refer to page 54-57

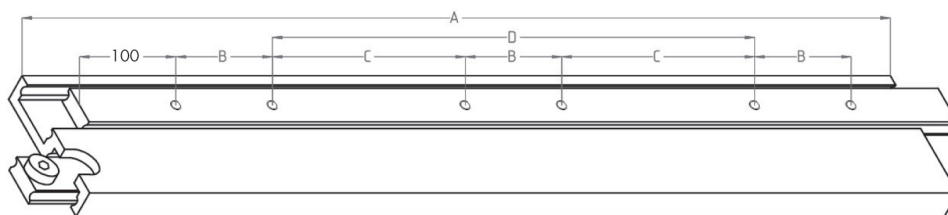
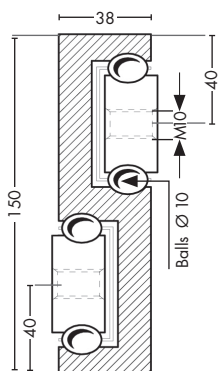

15038*	A**	B	C	D	W***	L****
	mm	mm	mm	mm	kg	kg
15038 - 80	800	100	150	-	38,00	1500
15038 - 85	850	100	175	-	40,38	1450
15038 - 90	900	100	200	-	42,80	1390
15038 - 95	950	100	225	-	45,13	1350
15038 - 100	1000	100	250	-	48,00	1310
15038 - 105	1050	100	275	-	49,88	1290
15038 - 110	1100	100	300	-	52,20	1250
15038 - 115	1150	100	325	-	54,63	1210
15038 - 120	1200	100	350	-	59,20	1180
15038 - 125	1250	100	375	-	59,38	1140
15038 - 130	1300	100	400	-	59,40	1110
15038 - 135	1350	100	425	-	64,13	1080
15038 - 140	1400	100	450	-	63,30	1040
15038 - 145	1450	100	475	-	68,88	1010
15038 - 150	1500	100	500	-	70,80	990
15038 - 155	1550	100	525	-	73,63	965
15038 - 160	1600	100	550	-	74,30	935
15038 - 165	1650	100	575	-	78,38	900
15038 - 170	1700	100	600	-	77,60	880
15038 - 175	1750	100	625	-	83,13	840
15038 - 180	1800	100	650	-	82,70	810
15038 - 185	1850	100	675	-	87,88	775
15038 - 190	1900	100	700	-	87,40	730
15038 - 195	1950	100	725	-	92,63	700
15038 - 200	2000	100	750	-	93,10	660

\* Consider prefix when ordering. ST = Steel C45 zinc coated, NI = NIROSTA Stainless steel, AL = Aluminium  
 \*\*\* Weight per unit      \*\*\*\* Load rating per rail pair

\*\* A = Length of the rail in inserted position

A large grid of small dots for taking notes, covering the majority of the page area.

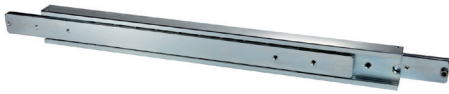

## 14555

**Material**  
Steel C45 zinc coated,  
stainless steel or aluminium

**Load rating**  
Up to 2700 kg

**Extension**  
Full extension

**Profile**  
H = 145 mm, B = 55 mm

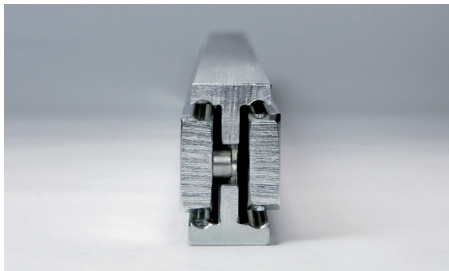

Optional extension in both directions

### Description

- Length of the rail = Extension of the rail
- Load per pair in extended position, balanced weight distribution and vertical rail structure.

### Advice

- Appropriate to the applicable length the fixation is carried out with twelve M10 threaded holes.
- Forward and backward movement is possible with an optional process locking.
- Custom-made products are possible due to our in-house production. (length, pattern of drilling).



- For more information refer to page 54-57

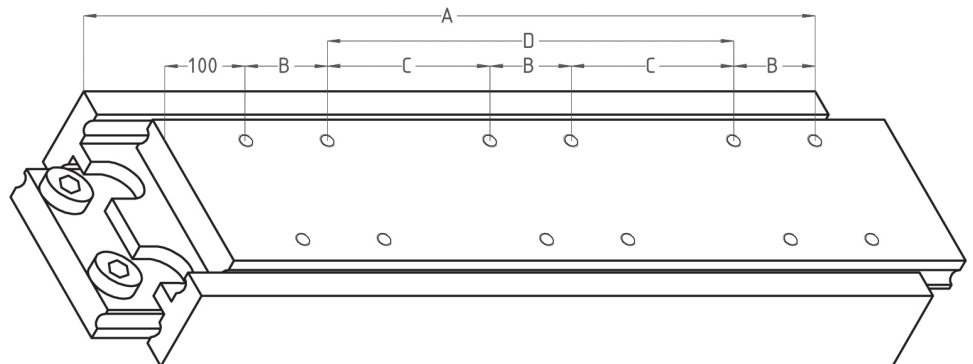
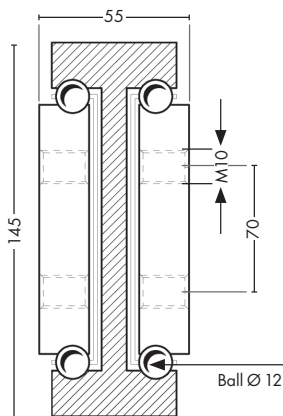

14555*	A** mm	B mm	C mm	D mm	W*** kg	L**** kg
14555 - 80	800	100	150	-	37,64	2200
14555 - 85	850	100	175	-	39,99	2300
14555 - 90	900	100	200	-	42,35	2400
14555 - 95	950	100	225	-	44,70	2500
14555 - 100	1000	100	250	-	47,05	2550
14555 - 105	1050	100	275	-	49,41	2500
14555 - 110	1100	100	300	-	51,76	2450
14555 - 115	1150	100	325	-	54,11	2400
14555 - 120	1200	100	350	-	56,46	2500
14555 - 125	1250	100	375	-	58,82	2600
14555 - 130	1300	100	400	-	61,17	2700
14555 - 135	1350	100	425	-	63,52	2700
14555 - 140	1400	100	450	-	65,87	2600
14555 - 145	1450	100	475	-	68,23	2550
14555 - 150	1500	100	500	-	70,58	2500
14555 - 155	1550	100	525	-	72,93	2450
14555 - 160	1600	100	550	-	75,28	2400
14555 - 165	1650	100	575	-	77,64	2350
14555 - 170	1700	100	600	-	79,99	2300
14555 - 175	1750	100	625	-	82,34	2250
14555 - 180	1800	100	650	-	84,69	2200
14555 - 185	1850	100	675	-	87,05	2150
14555 - 190	1900	100	700	-	89,40	2100
14555 - 195	1950	100	725	-	91,75	2050
14555 - 200	2000	100	750	-	94,11	2000
14555 - 210	2100	100	800	-	100,80	1800
14555 - 220	2200	100	850	-	105,60	1600
14555 - 230	2300	100	900	-	110,40	1400
14555 - 240	2400	100	950	-	115,20	1200
14555 - 250	2500	100	1000	-	120,20	1100

\* Consider prefix when ordering. ST = Steel C45 zinc coated, NI = NIROSTA Stainless steel, AL = Aluminium  
 \*\*\* Weight per unit \*\*\*\* Load rating per rail pair

\*\* A = Length of the rail in inserted position

## 4020



**Material**  
Steel C45 zinc coated,  
stainless steel or aluminium

**Load rating**  
Up to 245 kg

**Profile**  
H = 20 mm, B = 40 mm

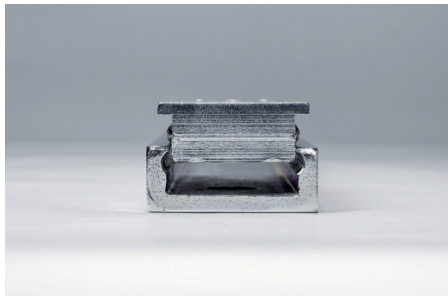

Fig. differs from delivery package. Or-  
der vehicles separately..

### Description

- Linear guide is suitable to carry objects
- The linear guide is available in different lengths from 300 mm up to a maximum of 3000 mm.
- Weight per steel meter (C45) = 6,40 kg
- Weight per aluminium meter = 2,16 kg
- Load per vehicle in balanced weight distribution and vertical rail structure.
- Horizontal installation is possible too
- Appropriate to the length of the rail and its weight the fixation is carried out with M6 counter sunk drillings.

### Advice

- No automatic duplication of the maximum load of 245 kg when using two or more vehicles.
- Order vehicles that are included in the deliver package separately

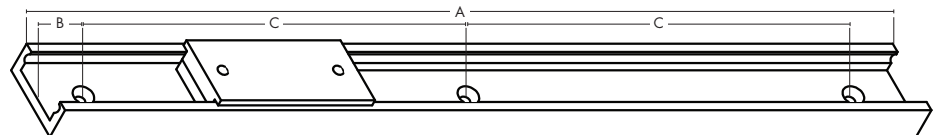
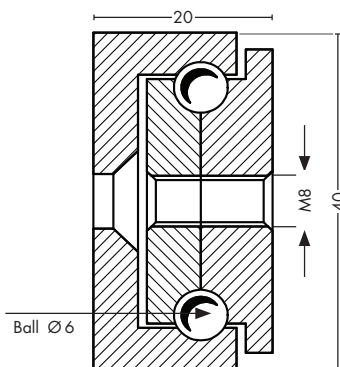

4020 *	A**	B	C
	mm	mm	mm
4020 - 30	300	25	...
4020 - ...	...	25	...
4020 - 300	bis 3000	25	...

\* Consider prefix when ordering. ST = Steel C45 zinc coated, NI = NIROSTA Stainless steel, AL = Aluminium

\*\* A = Length of the rail in inserted position

**Description**

- Suitable to carry objects in appropriate guiding device.
- The linear guide is available in different lengths from 300 mm up to a maximum of 3000 mm.

**Advice**

- Order vehicles as singles
- The vehicle will be mounted to the object being transported with two centrally positioned M8 threaded holes.
- No automatic duplication of the maximum load of 245 kg when using two or more vehicles.
- Custom-made products are possible due to our in-house production. (length, pattern of drilling).



- For more information refer to page 54-57

## 4020

**Material**

Steel C45 zinc coated,  
stainless steel or aluminium

**Load rating**

Up to 245 kg

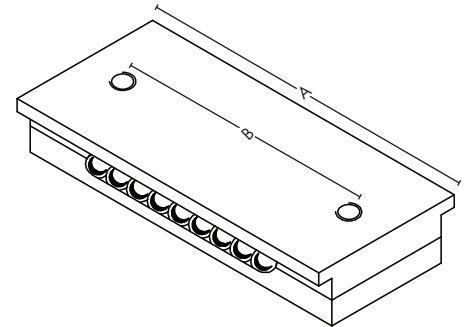

Vehicle*	A** mm	B mm	Load rating / Vehicle kg
4020080	80	60	220
4020120	120	100	245

\* Consider prefix when ordering. ST = Steel C45 zinc coated, NI = NIROSTA Stainless steel, AL = Aluminium

\*\* A = Length of vehicle

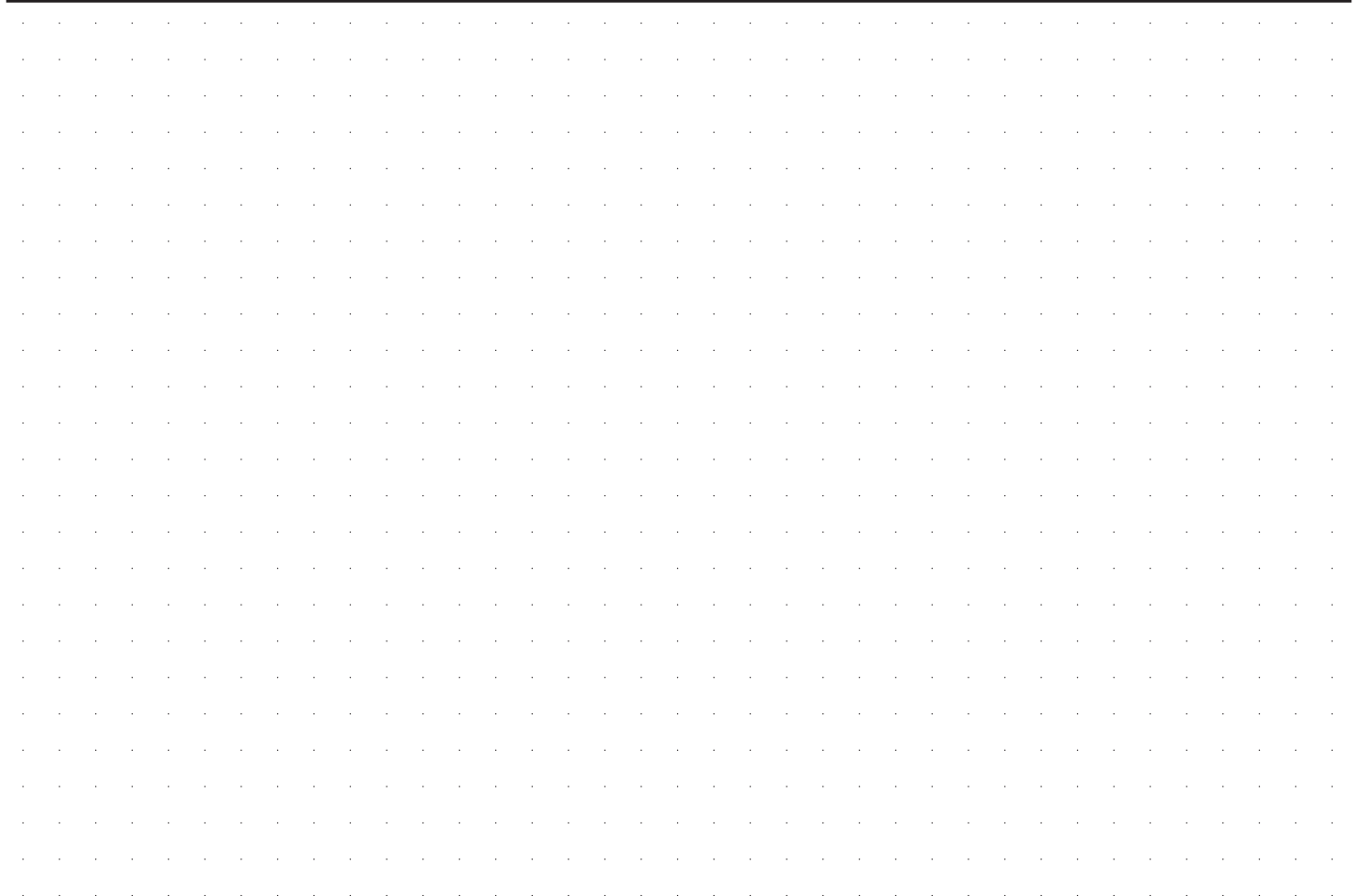

A large grid of small dots for taking notes, covering the majority of the page.



A large grid of small dots for taking notes, covering the majority of the page.

All information in this catalogue is up to date when published. Adjustments due to new developments, product launches or errors are subject to corrections.

We apologise for any errors made.

This document and the information contained are subject to copyright law.

Full or partial reprint may only be allowed with written permission by Leschhorn GmbH & Co. KG.

If you have any questions, comments or suggestions; we value your opinion – please get in touch!

Conception and contents:  
Rabea Hans - Marketing  
rabea.hans@leschhorn.de

This product is produced on a  
Co2 neutral basis.

**Leschhorn GmbH & Co. KG**  
Technische Komponenten für  
Industrie und Handwerk

Schlitzerstraße 6  
60386 Frankfurt  
Phone: 0049 69 - 420 97 60  
Fax: 0049 69 - 41 92 38  
info@leschhorn.de  
www.leschhorn.de