

BODYBUILDER™ BOOM STRUCTURE

BodyBuilder™ Octagonal Tooling | Dimensions

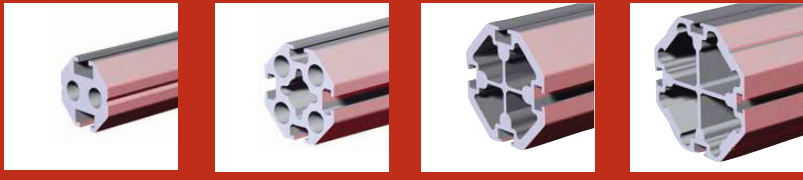

30, 45, 60, and 90mm Boom Lengths and Ordering Numbers

BODYBUILDER™ OCTAGONAL ALUMINUM BOOM LENGTHS & ORDER NUMBERS				
	(L) Length	B - 30 - (L) - 0	B - 45 - (L) - 0	B - 60 - (L) - 0
150 mm	B - 30 - 150 - 0	B - 45 - 150 - 0	B - 60 - 150 - 0	N/A
200 mm	B - 30 - 200 - 0	B - 45 - 200 - 0	B - 60 - 200 - 0	N/A
250 mm	B - 30 - 250 - 0	B - 45 - 250 - 0	B - 60 - 250 - 0	N/A
300 mm	B - 30 - 300 - 0	B - 45 - 300 - 0	B - 60 - 300 - 0	B - 90 - 300 - 0
400 mm	B - 30 - 400 - 0	B - 45 - 400 - 0	B - 60 - 400 - 0	B - 90 - 400 - 0
500 mm	B - 30 - 500 - 0	B - 45 - 500 - 0	B - 60 - 500 - 0	B - 90 - 500 - 0
600 mm	B - 30 - 600 - 0	B - 45 - 600 - 0	B - 60 - 600 - 0	B - 90 - 600 - 0
700 mm	B - 30 - 700 - 0	B - 45 - 700 - 0	B - 60 - 700 - 0	B - 90 - 700 - 0
750 mm	B - 30 - 750 - 0	B - 45 - 750 - 0	B - 60 - 750 - 0	B - 90 - 750 - 0
800 mm	B - 30 - 800 - 0	B - 45 - 800 - 0	B - 60 - 800 - 0	B - 90 - 800 - 0
900 mm	B - 30 - 900 - 0	B - 45 - 900 - 0	B - 60 - 900 - 0	B - 90 - 900 - 0
1200 mm	B - 30 - 1200 - 0	B - 45 - 1200 - 0	B - 60 - 1200 - 0	B - 90 - 1200 - 0
1500 mm	B - 30 - 1500 - 0	B - 45 - 1500 - 0	B - 60 - 1500 - 0	B - 90 - 1500 - 0
1800 mm	B - 30 - 1800 - 0	B - 45 - 1800 - 0	B - 60 - 1800 - 0	B - 90 - 1800 - 0
2100 mm	B - 30 - 2100 - 0	B - 45 - 2100 - 0	B - 60 - 2100 - 0	B - 90 - 2100 - 0
2400 mm	B - 30 - 2400 - 0	B - 45 - 2400 - 0	B - 60 - 2400 - 0	B - 90 - 2400 - 0
2700 mm	B - 30 - 2700 - 0	B - 45 - 2700 - 0	B - 60 - 2700 - 0	B - 90 - 2700 - 0
3000 mm	B - 30 - 3000 - 0	B - 45 - 3000 - 0	B - 60 - 3000 - 0	B - 90 - 3000 - 0

30mm Boom Profile Dimensions and Specifications

BodyBuilder™ 30mm Boom

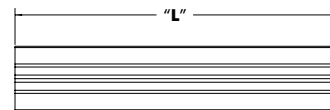
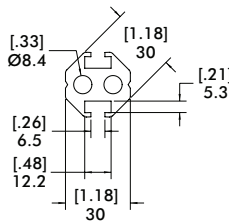
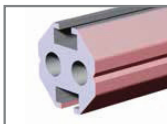

Model Number	Weight
B - 30 - (L) - 0	1.4 kg/m [0.9 lb/ft]

Dimensions and technical information are subject to change without notice



BODYBUILDER™ BOOM STRUCTURE

BodyBuilder™ Octagonal Tooling | Dimensions

45, 60, and 90mm Boom Profile Dimensions and Specifications

BodyBuilder™ 45mm Boom

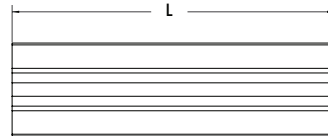
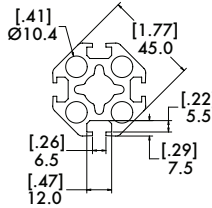
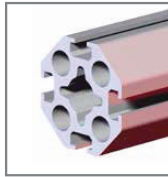

Model Number	Weight
B - 45 - (L) - 0	2.0 kg/m [1.4 lb/ft]

BodyBuilder™ 60mm Boom

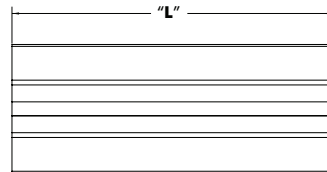
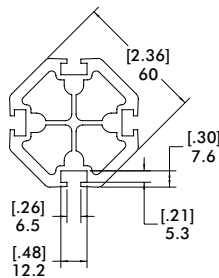
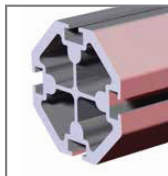

Model Number	Weight
B - 60 - (L) - 0	3.3 kg/m [2.2 lb/ft]

BodyBuilder™ 90mm Boom

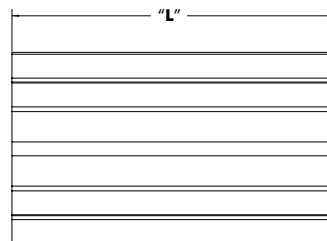
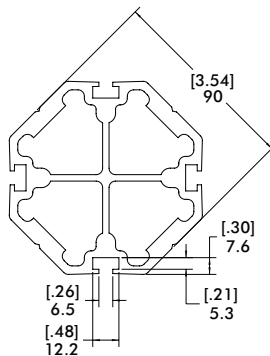
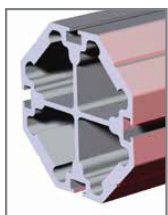

Model Number	Weight
B - 90 - (L) - 0	6.5 kg/m [4.4 lb/ft]

Dimensions and technical information are subject to change without notice

BODYBUILDER™ BOOM STRUCTURE

BodyBuilder™ Octagonal Tooling | Technical Specifications



30mm Boom Deflection and Torsion Charts

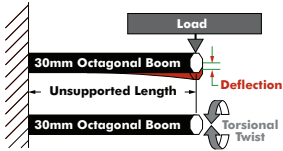

5 Kgf	11.0 lbf
10 Kgf	22.0 lbf
15 Kgf	33.0 lbf

100 Kgf-cm	86.8 lbf-in
200 Kgf-cm	173.6 lbf-in
300 Kgf-cm	260.4 lbf-in
400 Kgf-cm	347.2 lbf-in
800 Kgf-cm	694.4 lbf-in
1300 Kgf-cm	1128.4 lbf-in

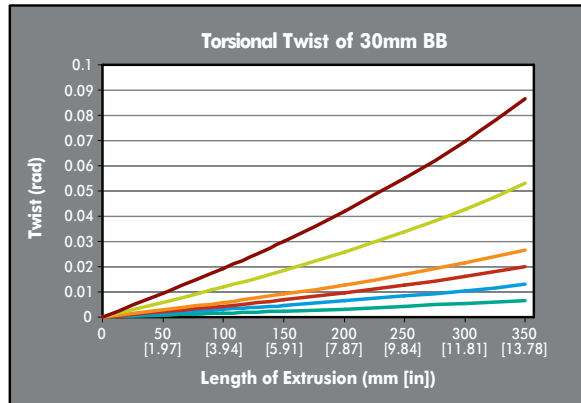
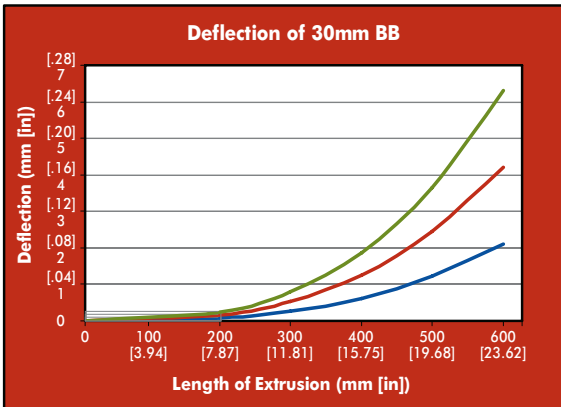
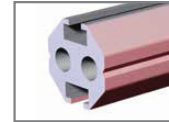

45mm Boom Deflection and Torsion Charts

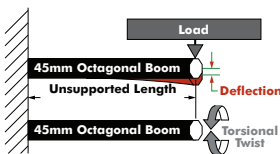

5 Kgf	11.0 lbf
10 Kgf	22.0 lbf
20 Kgf	44.1 lbf
30 Kgf	66.1 lbf
40 Kgf	88.2 lbf

400 Kgf-cm	347.2 lbf-in
700 Kgf-cm	607.6 lbf-in
1000 Kgf-cm	867.0 lbf-in
1300 Kgf-cm	1128.4 lbf-in
1600 Kgf-cm	1388.7 lbf-in
2000 Kgf-cm	1735.9 lbf-in
3000 Kgf-cm	2603.9 lbf-in

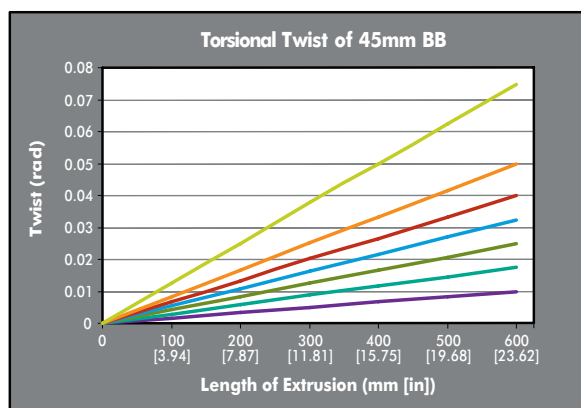
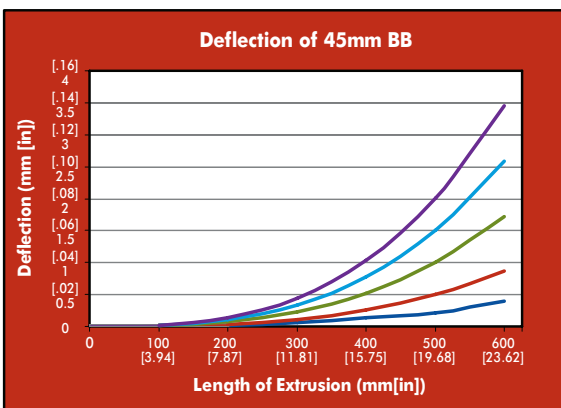
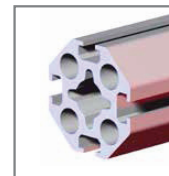

Note: Performance may vary if used with non-DESTACO components

Dimensions and technical information are subject to change without notice



BODYBUILDER™ BOOM STRUCTURE

BodyBuilder™ Octagonal Tooling | Technical Specifications

60mm Boom Deflection and Torsion Charts

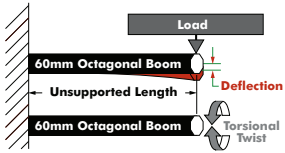

5 Kgf	11.0 lbf
10 Kgf	22.0 lbf
20 Kgf	44.1 lbf
30 Kgf	66.1 lbf
40 Kgf	88.2 lbf
50 Kgf	110.2 lbf

400 Kgf-cm	347.2 lbf-in
800 Kgf-cm	694.4 lbf-in
1200 Kgf-cm	1041.6 lbf-in
1600 Kgf-cm	1388.7 lbf-in
2000 Kgf-cm	1735.9 lbf-in
2400 Kgf-cm	2083.1 lbf-in
2800 Kgf-cm	2430.3 lbf-in
3400 Kgf-cm	2951.1 lbf-in
4000 Kgf-cm	3471.8 lbf-in

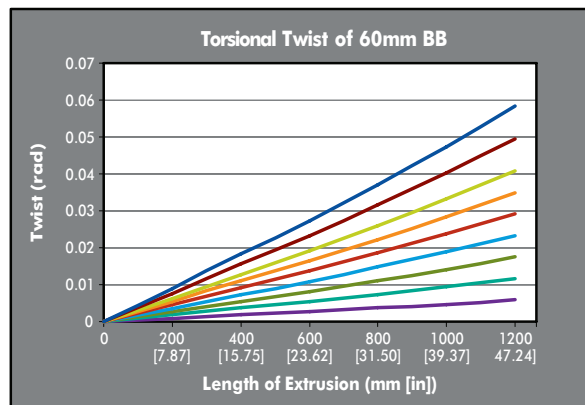
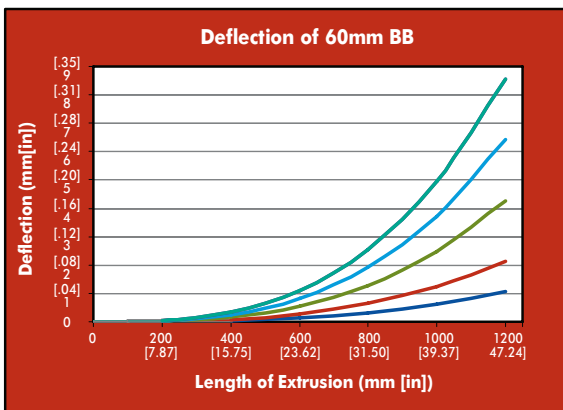
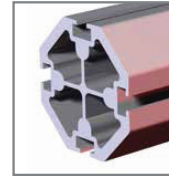

90mm Boom Deflection and Torsion Charts

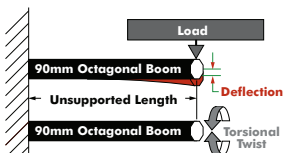

10 Kgf	22.0 lbf
20 Kgf	44.1 lbf
30 Kgf	66.1 lbf
40 Kgf	88.2 lbf
50 Kgf	110.2 lbf
60 Kgf	132.3 lbf

1000 Kgf-cm	867.0 lbf-in
2000 Kgf-cm	1735.9 lbf-in
3000 Kgf-cm	2603.9 lbf-in
4000 Kgf-cm	3471.8 lbf-in
5000 Kgf-cm	4339.8 lbf-in
6000 Kgf-cm	5207.8 lbf-in
8000 Kgf-cm	6943.7 lbf-in

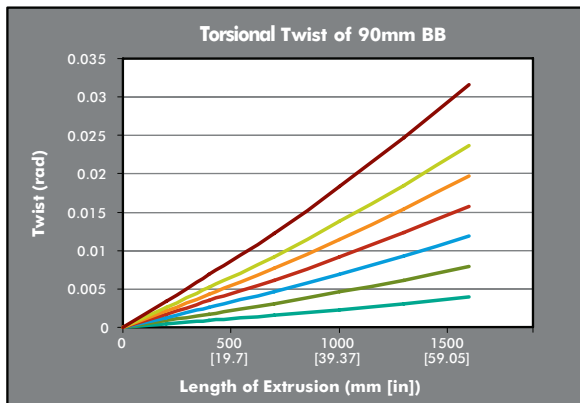
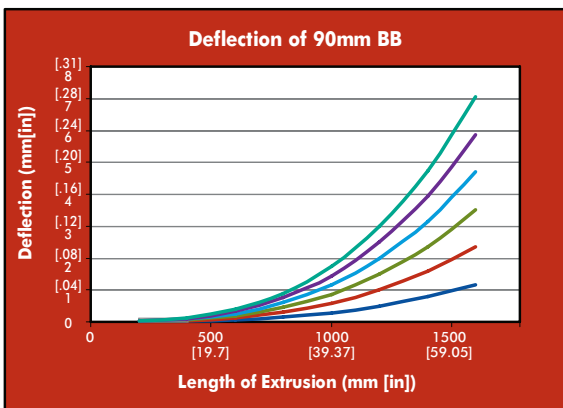
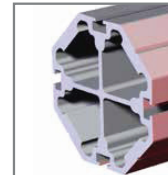

Note: Performance may vary if used with non-DESTACO components

Dimensions and technical information are subject to change without notice

BODYBUILDER™ BOOM STRUCTURE ACCESSORIES

BodyBuilder™ Octagonal Tooling | Dimensions | Technical Specifications



ETP-35 Extrusion Accessory Mount



Specifications:
Material: Aluminum

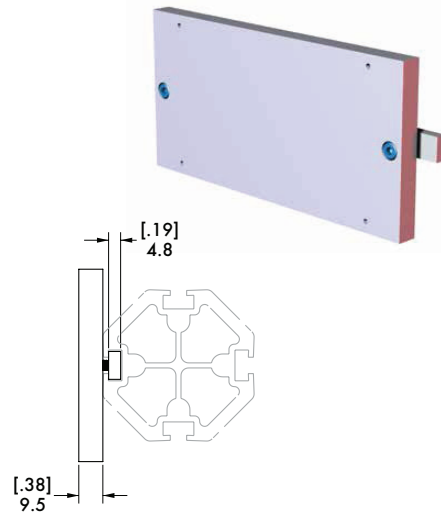
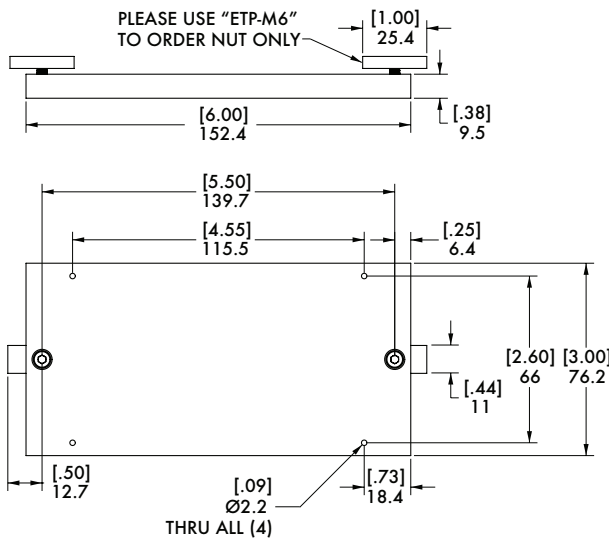

Model Number	Weight
CPI-ETP-35	.31 kg [.68 lb]

EC-60 60mm Bodybuilder Octagonal Boom End Cap

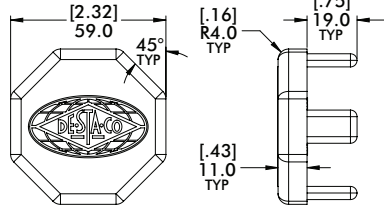
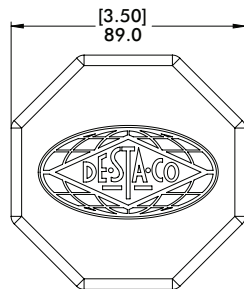

End Cap

60mm End Cap

45mm End Cap

Model Number	Weight
CPI-EC-45B	.02 kg [.05 lb]
CPI-EC-60B	.04 kg [.09 lb]
CPI-EC-90B	.09 kg [.20 lb]

Dimensions and technical information are subject to change without notice