

## Kugelsperbolzen • einfach wirkend - nach NAS / MS17985

EH 4211.



### Produktbeschreibung

Kugelsperbolzen nach MS17985 / NAS1333-1341 werden zum raschen Fixieren, Arretieren, Verstellen, Wechseln und Sichern eingesetzt. Schnell und einfach lösbar für häufig wiederholende Verbindungen.

Die Kugelsperbolzen (Quick Release Pins / Ball Lock Pins) sind nach Luftfahrtnorm MS / NAS gefertigt und nach NAS 1332 geprüft.

Oberflächenbehandlung:

- Alle Teile aus rostfreiem Stahl passiviert gemäß AMS2700
- Alle Teile aus Aluminium anodisiert gemäß MIL-A-8625

Wärmebehandlung:

- Hülse: Rc. 40 min. (AMS2759, Condition H900)
- Bolzen: Rc. 40 min. (AMS2759, Condition H900)
- Kugel: Rc. 58-62 min. (AMS2759)

### Werkstoff

#### Hülse

- Rostfreier Stahl, ausscheidungsgehärtet, passiviert - CRES 17-4PH (Spezifikation AMS5643)

#### Bolzen

- Rostfreier Stahl, ausscheidungsgehärtet, passiviert - CRES 17-4PH (Spezifikation AMS5643)

#### Feder

- Rostfreier Stahl, passiviert - CRES 302 (Spezifikation ASTM-A-313)

#### Griff

- Aluminium, schwarz anodisiert - Alum.Alloy 380 (Spezifikation ASTM B85/B85)

#### Schlüsselring

- Rostfreier Stahl, passiviert - CRES 302 (Spezifikation ASTM A-313/A313M)

#### Druckknopf

- Rostfreier Stahl, passiviert - CRES 303 (Spezifikation ASTM A484/484M)

#### Kugel

- Rostfreier Stahl, ausscheidungsgehärtet, passiviert - CRES 440C (Spezifikation AMS5630)

### Bedienung

Kugelsperbolzen, einfach wirkend sind selbstsichernd. Durch Drücken des Knopfes werden die Kugeln entriegelt.

### Weiterführende Informationen

#### Hinweise

Alle weiteren Maßangaben erhalten Sie auf Anfrage.

Weitere nicht aufgeführte Durchmesser-/ Längen-Kombinationen, die der Norm entsprechen, können auf Kundenwunsch kurzfristig produziert werden. Sonderausführung auf Anfrage.

Sonderausführung auf Anfrage.



- Dieses Produkt ist in INCH-Abmessungen gefertigt.

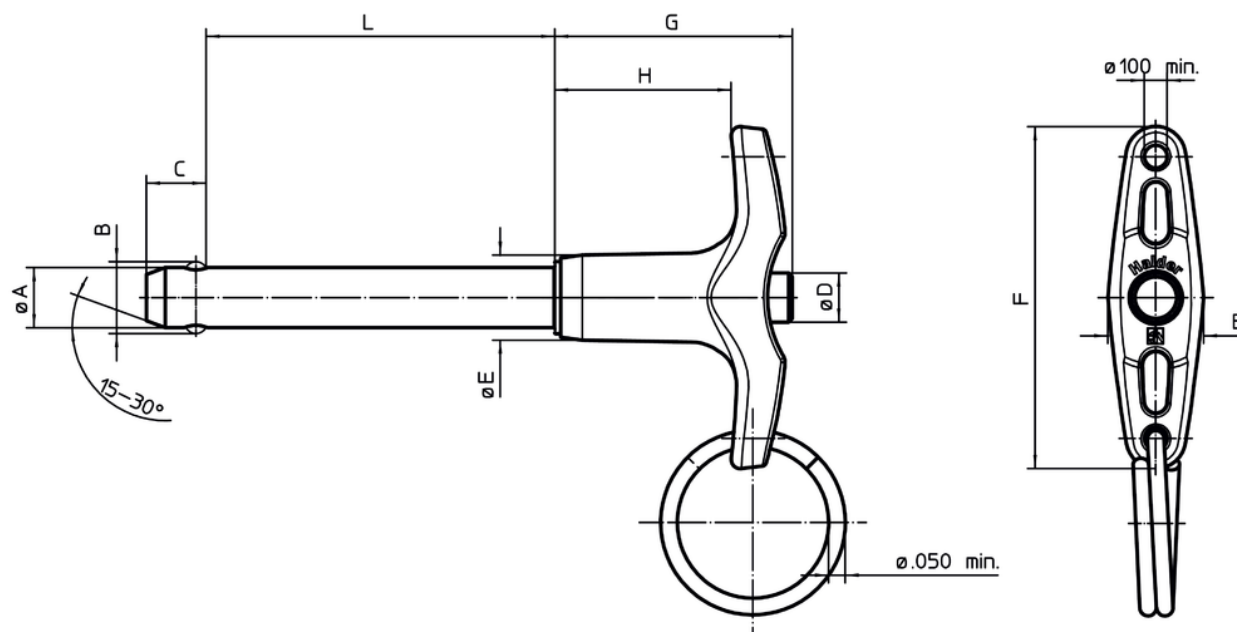

Maßzeichnung





Bestellinformationen

Nenn-durch-messer A	A min.	A max.	Klemm-länge L +0,02 0	Abmessungen							Aufnahme-bohrung max.	Scherfestigkeit zweischchnittig min.	Temperatur		Gewicht [g]	Norm-bezeichnung	Art.-Nr.
				B ±0,005	C 0 -0,04	D max.	E max.	F max.	G max.	H min.			min.	max.			
[in]	[in]	[in]	[in]	[in]							[in]	[lbf]	[°F]				
3/16	0,1870	0,1885	0,3	0,220	0,260	0,310	0,500	1,815	1,27	0,800	0,1940	5.150	-65	200	18,5	MS17985C303 / NAS1333A2C03D	4211.A03
3/16	0,1870	0,1885	0,4	0,220	0,260	0,310	0,500	1,815	1,27	0,800	0,1940	5.150	-65	200	18,8	MS17985C304 / NAS1333A2C04D	4211.A04
3/16	0,1870	0,1885	0,5	0,220	0,260	0,310	0,500	1,815	1,27	0,800	0,1940	5.150	-65	200	19,1	MS17985C305 / NAS1333A2C05D	4211.A05
3/16	0,1870	0,1885	0,6	0,220	0,260	0,310	0,500	1,815	1,27	0,800	0,1940	5.150	-65	200	19,5	MS17985C306 / NAS1333A2C06D	4211.A06
3/16	0,1870	0,1885	0,7	0,220	0,260	0,310	0,500	1,815	1,27	0,800	0,1940	5.150	-65	200	19,8	MS17985C307 / NAS1333A2C07D	4211.A07
3/16	0,1870	0,1885	0,8	0,220	0,260	0,310	0,500	1,815	1,27	0,800	0,1940	5.150	-65	200	20,2	MS17985C308 / NAS1333A2C08D	4211.A08
3/16	0,1870	0,1885	1,0	0,220	0,260	0,310	0,500	1,815	1,27	0,800	0,1940	5.150	-65	200	20,8	MS17985C310 / NAS1333A2C10D	4211.A10
3/16	0,1870	0,1885	1,1	0,220	0,260	0,310	0,500	1,815	1,27	0,800	0,1940	5.150	-65	200	21,2	MS17985C310 / NAS1333A2C11D	4211.A11
3/16	0,1870	0,1885	1,2	0,220	0,260	0,310	0,500	1,815	1,27	0,800	0,1940	5.150	-65	200	21,5	MS17985C312 / NAS1333A2C12D	4211.A12
3/16	0,1870	0,1885	1,3	0,220	0,260	0,310	0,500	1,815	1,27	0,800	0,1940	5.150	-65	200	21,9	MS17985C313 / NAS1333A2C13D	4211.A13
3/16	0,1870	0,1885	1,4	0,220	0,260	0,310	0,500	1,815	1,27	0,800	0,1940	5.150	-65	200	22,2	MS17985C314 / NAS1333A2C14D	4211.A14
3/16	0,1870	0,1885	1,5	0,220	0,260	0,310	0,500	1,815	1,27	0,800	0,1940	5.150	-65	200	22,5	MS17985C315 / NAS1333A2C15D	4211.A15
3/16	0,1870	0,1885	2,0	0,220	0,260	0,310	0,500	1,815	1,27	0,800	0,1940	5.150	-65	200	24,2	MS17985C320 / NAS1333A2C20D	4211.A20
3/16	0,1870	0,1885	2,1	0,220	0,260	0,310	0,500	1,815	1,27	0,800	0,1940	5.150	-65	200	24,6	MS17985C321 / NAS1333A2C21D	4211.A21
3/16	0,1870	0,1885	2,2	0,220	0,260	0,310	0,500	1,815	1,27	0,800	0,1940	5.150	-65	200	24,9	MS17985C322 / NAS1333A2C22D	4211.A22
3/16	0,1870	0,1885	2,3	0,220	0,260	0,310	0,500	1,815	1,27	0,800	0,1940	5.150	-65	200	25,3	MS17985C323 / NAS1333A2C23D	4211.A23
3/16	0,1870	0,1885	2,5	0,220	0,260	0,310	0,500	1,815	1,27	0,800	0,1940	5.150	-65	200	25,9	MS17985C325 / NAS1333A2C25D	4211.A25
3/16	0,1870	0,1885	2,6	0,220	0,260	0,310	0,500	1,815	1,27	0,800	0,1940	5.150	-65	200	26,3	MS17985C326 / NAS1333A2C26D	4211.A26



Nenn- durch- messer A	A min.	A max.	Klemm- länge L +0,02 0	Abmessungen							Aufnahme- bohrung max.	Scherfestigkeit zweischneittig min.	 min. max.		 [g]	Norm- bezeichnung	Art.-Nr.
				B ±0,005	C 0 -0,04	D max.	E max.	F max.	G max.	H min.			[in]	[lbf]			
[in]	[in]	[in]	[in]	[in]							[in]						
3/16	0,1870	0,1885	4,5	0,220 in	0,260	0,310	0,500	1,815	1,27	0,800	0,1940	5.150	-65	200	32,7	MS17985C345 / NAS1334A2C45D	4211.A45
3/16	0,1870	0,1885	6,0	0,220 in	0,260	0,310	0,500	1,815	1,27	0,800	0,1940	5.150	-65	200	37,8	MS17985C360 / NAS1334A2C60D	4211.A60
1/4	0,2470	0,2485	0,5	0,289 in	0,290	0,310	0,500	1,815	1,27	0,800	0,2540	9.200	-65	200	21,5	MS17985C405 / NAS1334A2C05D	4211.B05
1/4	0,2470	0,2485	0,6	0,289 in	0,290	0,310	0,500	1,815	1,27	0,800	0,2540	9.200	-65	200	22,1	MS17985C406 / NAS1334A2C06D	4211.B06
1/4	0,2470	0,2485	0,7	0,289 in	0,290	0,310	0,500	1,815	1,27	0,800	0,2540	9.200	-65	200	22,7	MS17985C407 / NAS1334A2C07D	4211.B07
1/4	0,2470	0,2485	0,8	0,289 in	0,290	0,310	0,500	1,815	1,27	0,800	0,2540	9.200	-65	200	23,3	MS17985C408 / NAS1334A2C08D	4211.B08
1/4	0,2470	0,2485	0,9	0,289 in	0,290	0,310	0,500	1,815	1,27	0,800	0,2540	9.200	-65	200	23,9	MS17985C409 / NAS1334A2C09D	4211.B09
1/4	0,2470	0,2485	1,0	0,289 in	0,290	0,310	0,500	1,815	1,27	0,800	0,2540	9.200	-65	200	24,5	MS17985C410 / NAS1334A2C10D	4211.B10
1/4	0,2470	0,2485	1,1	0,289 in	0,290	0,310	0,500	1,815	1,27	0,800	0,2540	9.200	-65	200	25,2	MS17985C411 / NAS1334A2C11D	4211.B11
1/4	0,2470	0,2485	1,2	0,289 in	0,290	0,310	0,500	1,815	1,27	0,800	0,2540	9.200	-65	200	25,8	MS17985C412 / NAS1334A2C12D	4211.B12
1/4	0,2470	0,2485	1,3	0,289 in	0,290	0,310	0,500	1,815	1,27	0,800	0,2540	9.200	-65	200	26,4	MS17985C413 / NAS1334A2C13D	4211.B13
1/4	0,2470	0,2485	1,4	0,289 in	0,290	0,310	0,500	1,815	1,27	0,800	0,2540	9.200	-65	200	27,0	MS17985C414 / NAS1334A2C14D	4211.B14
1/4	0,2470	0,2485	1,5	0,289 in	0,290	0,310	0,500	1,815	1,27	0,800	0,2540	9.200	-65	200	27,6	MS17985C415 / NAS1334A2C15D	4211.B15
1/4	0,2470	0,2485	1,6	0,289 in	0,290	0,310	0,500	1,815	1,27	0,800	0,2540	9.200	-65	200	28,2	MS17985C416 / NAS1334A2C16D	4211.B16
1/4	0,2470	0,2485	1,7	0,289 in	0,290	0,310	0,500	1,815	1,27	0,800	0,2540	9.200	-65	200	28,8	MS17985C417 / NAS1334A2C17D	4211.B17
1/4	0,2470	0,2485	1,8	0,289 in	0,290	0,310	0,500	1,815	1,27	0,800	0,2540	9.200	-65	200	29,5	MS17985C418 / NAS1334A2C18D	4211.B18
1/4	0,2470	0,2485	2,0	0,289 in	0,290	0,310	0,500	1,815	1,27	0,800	0,2540	9.200	-65	200	30,7	MS17985C420 / NAS1334A2C20D	4211.B20
1/4	0,2470	0,2485	2,1	0,289 in	0,290	0,310	0,500	1,815	1,27	0,800	0,2540	9.200	-65	200	31,3	MS17985C421 / NAS1334A2C21D	4211.B21
1/4	0,2470	0,2485	2,3	0,289 in	0,290	0,310	0,500	1,815	1,27	0,800	0,2540	9.200	-65	200	32,5	MS17985C423 / NAS1334A2C23D	4211.B23
1/4	0,2470	0,2485	2,4	0,289 in	0,290	0,310	0,500	1,815	1,27	0,800	0,2540	9.200	-65	200	33,1	MS17985C424 / NAS1334A2C24D	4211.B24
1/4	0,2470	0,2485	2,5	0,289 in	0,290	0,310	0,500	1,815	1,27	0,800	0,2540	9.200	-65	200	33,8	MS17985C425 / NAS1334A2C25D	4211.B25
1/4	0,2470	0,2485	2,6	0,289 in	0,290	0,310	0,500	1,815	1,27	0,800	0,2540	9.200	-65	200	34,4	MS17985C426 / NAS1334A2C26D	4211.B26
1/4	0,2470	0,2485	2,7	0,289 in	0,290	0,310	0,500	1,815	1,27	0,800	0,2540	9.200	-65	200	35,0	MS17985C427 / NAS1334A2C27D	4211.B27
1/4	0,2470	0,2485	2,8	0,289 in	0,290	0,310	0,500	1,815	1,27	0,800	0,2540	9.200	-65	200	35,6	MS17985C428 / NAS1334A2C28D	4211.B28
1/4	0,2470	0,2485	2,9	0,289 in	0,290	0,310	0,500	1,815	1,27	0,800	0,2540	9.200	-65	200	36,2	MS17985C429 / NAS1334A2C29D	4211.B29
1/4	0,2470	0,2485	3,0	0,289 in	0,290	0,310	0,500	1,815	1,27	0,800	0,2540	9.200	-65	200	36,8	MS17985C430 / NAS1334A2C30D	4211.B30
1/4	0,2470	0,2485	3,1	0,289 in	0,290	0,310	0,500	1,815	1,27	0,800	0,2540	9.200	-65	200	37,4	MS17985C431 / NAS1334A2C31D	4211.B31
1/4	0,2470	0,2485	3,2	0,289 in	0,290	0,310	0,500	1,815	1,27	0,800	0,2540	9.200	-65	200	38,1	MS17985C432 / NAS1334A2C32D	4211.B32
1/4	0,2470	0,2485	3,5	0,289 in	0,290	0,310	0,500	1,815	1,27	0,800	0,2540	9.200	-65	200	39,9	MS17985C435 / NAS1334A2C35D	4211.B35
1/4	0,2470	0,2485	4,0	0,289 in	0,290	0,310	0,500	1,815	1,27	0,800	0,2540	9.200	-65	200	43,0	MS17985C440 / NAS1334A2C40D	4211.B40
1/4	0,2470	0,2485	5,0	0,289 in	0,290	0,310	0,500	1,815	1,27	0,800	0,2540	9.200	-65	200	49,1	MS17985C450 / NAS1334A2C50D	4211.B50
1/4	0,2470	0,2485	5,2	0,289 in	0,290	0,310	0,500	1,815	1,27	0,800	0,2540	9.200	-65	200	50,4	MS17985C452 / NAS1334A2C52D	4211.B52

Nenn- durch- messer A	A min.	A max.	Klemm- länge L +0,02 0	Abmessungen							Aufnahme- bohrung max.	Scherfestigkeit zweischneittig min.	 min. max.		 [g]	Norm- bezeichnung	Art.-Nr.
				B ±0,005	C 0 -0,04	D max.	E max.	F max.	G max.	H min.			[in]	[lbf]			
[in]	[in]	[in]	[in]	[in]							[in]						
1/4	0,2470	0,2485	6,0	0,289 in	0,290	0,310	0,500	1,815	1,27	0,800	0,2540	9.200	-65	200	55,3	MS17985C460 / NAS1334A2C60D	4211.B60
5/16	0,3095	0,3110	0,3	0,375 in	0,330	0,310	0,500	1,815	1,27	0,800	0,3165	14.400	-65	200	23,1	MS17985C503 / NAS1335A2C03D	4211.C03
5/16	0,3095	0,3110	0,4	0,375 in	0,330	0,310	0,500	1,815	1,27	0,800	0,3165	14.400	-65	200	24,0	MS17985C504 / NAS1335A2C04D	4211.C04
5/16	0,3095	0,3110	0,5	0,375 in	0,330	0,310	0,500	1,815	1,27	0,800	0,3165	14.400	-65	200	25,0	MS17985C505 / NAS1335A2C05D	4211.C05
5/16	0,3095	0,3110	0,6	0,375 in	0,330	0,310	0,500	1,815	1,27	0,800	0,3165	14.400	-65	200	26,0	MS17985C506 / NAS1335A2C06D	4211.C06
5/16	0,3095	0,3110	0,8	0,375 in	0,330	0,310	0,500	1,815	1,27	0,800	0,3165	14.400	-65	200	27,8	MS17985C508 / NAS1335A2C08D	4211.C08
5/16	0,3095	0,3110	0,9	0,375 in	0,330	0,310	0,500	1,815	1,27	0,800	0,3165	14.400	-65	200	28,8	MS17985C509 / NAS1335A2C09D	4211.C09
5/16	0,3095	0,3110	1,0	0,375 in	0,330	0,310	0,500	1,815	1,27	0,800	0,3165	14.400	-65	200	29,7	MS17985C510 / NAS1335A2C10D	4211.C10
5/16	0,3095	0,3110	1,1	0,375 in	0,330	0,310	0,500	1,815	1,27	0,800	0,3165	14.400	-65	200	30,7	MS17985C511 / NAS1335A2C11D	4211.C11
5/16	0,3095	0,3110	1,2	0,375 in	0,330	0,310	0,500	1,815	1,27	0,800	0,3165	14.400	-65	200	31,6	MS17985C512 / NAS1335A2C12D	4211.C12
5/16	0,3095	0,3110	1,3	0,375 in	0,330	0,310	0,500	1,815	1,27	0,800	0,3165	14.400	-65	200	32,6	MS17985C513 / NAS1335A2C13D	4211.C13
5/16	0,3095	0,3110	1,5	0,375 in	0,330	0,310	0,500	1,815	1,27	0,800	0,3165	14.400	-65	200	34,5	MS17985C515 / NAS1335A2C15D	4211.C15
5/16	0,3095	0,3110	1,6	0,375 in	0,330	0,310	0,500	1,815	1,27	0,800	0,3165	14.400	-65	200	35,4	MS17985C516 / NAS1335A2C16D	4211.C16
5/16	0,3095	0,3110	1,8	0,375 in	0,330	0,310	0,500	1,815	1,27	0,800	0,3165	14.400	-65	200	37,3	MS17985C518 / NAS1335A2C18D	4211.C18
5/16	0,3095	0,3110	2,0	0,375 in	0,330	0,310	0,500	1,815	1,27	0,800	0,3165	14.400	-65	200	39,2	MS17985C520 / NAS1335A2C20D	4211.C20
5/16	0,3095	0,3110	2,2	0,375 in	0,330	0,310	0,500	1,815	1,27	0,800	0,3165	14.400	-65	200	41,1	MS17985C522 / NAS1335A2C22D	4211.C22
5/16	0,3095	0,3110	2,3	0,375 in	0,330	0,310	0,500	1,815	1,27	0,800	0,3165	14.400	-65	200	42,0	MS17985C523 / NAS1335A2C23D	4211.C23
5/16	0,3095	0,3110	2,4	0,375 in	0,330	0,310	0,500	1,815	1,27	0,800	0,3165	14.400	-65	200	43,0	MS17985C524 / NAS1335A2C24D	4211.C24
5/16	0,3095	0,3110	2,6	0,375 in	0,330	0,310	0,500	1,815	1,27	0,800	0,3165	14.400	-65	200	44,9	MS17985C526 / NAS1335A2C26D	4211.C26
5/16	0,3095	0,3110	2,8	0,375 in	0,330	0,310	0,500	1,815	1,27	0,800	0,3165	14.400	-65	200	46,8	MS17985C528 / NAS1335A2C28D	4211.C28
5/16	0,3095	0,3110	2,9	0,375 in	0,330	0,310	0,500	1,815	1,27	0,800	0,3165	14.400	-65	200	47,7	MS17985C529 / NAS1335A2C29D	4211.C29
5/16	0,3095	0,3110	3,0	0,375 in	0,330	0,310	0,500	1,815	1,27	0,800	0,3165	14.400	-65	200	48,7	MS17985C530 / NAS1335A2C30D	4211.C30
5/16	0,3095	0,3110	3,2	0,375 in	0,330	0,310	0,500	1,815	1,27	0,800	0,3165	14.400	-65	200	50,6	MS17985C532 / NAS1335A2C32D	4211.C32
5/16	0,3095	0,3110	3,3	0,375 in	0,330	0,310	0,500	1,815	1,27	0,800	0,3165	14.400	-65	200	51,5	MS17985C533 / NAS1335A2C33D	4211.C33
5/16	0,3095	0,3110	3,4	0,375 in	0,330	0,310	0,500	1,815	1,27	0,800	0,3165	14.400	-65	200	52,4	MS17985C534 / NAS1335A2C34D	4211.C34
5/16	0,3095	0,3110	3,5	0,375 in	0,330	0,310	0,500	1,815	1,27	0,800	0,3165	14.400	-65	200	53,4	MS17985C535 / NAS1335A2C35D	4211.C35
5/16	0,3095	0,3110	3,8	0,375 in	0,330	0,310	0,500	1,815	1,27	0,800	0,3165	14.400	-65	200	56,2	MS17985C538 / NAS1335A2C38D	4211.C38
5/16	0,3095	0,3110	4,0	0,375 in	0,330	0,310	0,500	1,815	1,27	0,800	0,3165	14.400	-65	200	58,1	MS17985C540 / NAS1335A2C40D	4211.C40
5/16	0,3095	0,3110	4,1	0,375 in	0,330	0,310	0,500	1,815	1,27	0,800	0,3165	14.400	-65	200	59,1	MS17985C541 / NAS1335A2C41D	4211.C41
5/16	0,3095	0,3110	4,2	0,375 in	0,330	0,310	0,500	1,815	1,27	0,800	0,3165	14.400	-65	200	60,0	MS17985C542 / NAS1335A2C42D	4211.C42
5/16	0,3095	0,3110	4,3	0,375 in	0,330	0,310	0,500	1,815	1,27	0,800	0,3165	14.400	-65	200	61,0	MS17985C543 / NAS1335A2C43D	4211.C43
5/16	0,3095	0,3110	5,0	0,375 in	0,330	0,310	0,500	1,815	1,27	0,800	0,3165	14.400	-65	200	67,6	MS17985C550 / NAS1335A2C50D	4211.C50

Nenn- durch- messer A	A min.	A max.	Klemm- länge L +0,02 0	Abmessungen							Aufnahme- bohrung max.	Scherfestigkeit zweischneittig min.	 min. max.		 [g]	Norm- bezeichnung	Art.-Nr.
				B ±0,005	C 0 -0,04	D max.	E max.	F max.	G max.	H min.			[°F]	[lb]			
[in]	[in]	[in]	[in]	[in]							[in]	[lb]	[°F]	[g]			
5/16	0,3095	0,3110	6,0	0,375 in	0,330	0,310	0,500	1,815	1,27	0,800	0,3165	14.400	-65	200	77,1	MS17985C560 / NAS1335A2C60D	4211.C60
5/16	0,3095	0,3110	6,4	0,375 in	0,330	0,310	0,500	1,815	1,27	0,800	0,3165	14.400	-65	200	80,8	MS17985C564 / NAS1335A2C64D	4211.C64
5/16	0,3095	0,3110	7,0	0,375 in	0,330	0,310	0,500	1,815	1,27	0,800	0,3165	14.400	-65	200	86,5	MS17985C570 / NAS1335A2C70D	4211.C70
3/8	0,3720	0,3735	0,9	0,440 in	0,365	0,390	0,625	2,065	1,45	0,850	0,3790	20.700	-65	200	43,5	MS17985C609 / NAS1336A2C09D	4211.D09
3/8	0,3720	0,3735	0,5	0,440 in	0,365	0,390	0,625	2,065	1,45	0,850	0,3790	20.700	-65	200	38,1	MS17985C605 / NAS1336A2C05D	4211.D05
3/8	0,3720	0,3735	0,7	0,440 in	0,365	0,390	0,625	2,065	1,45	0,850	0,3790	20.700	-65	200	40,8	MS17985C607 / NAS1336A2C07D	4211.D07
3/8	0,3720	0,3735	0,8	0,440 in	0,365	0,390	0,625	2,065	1,45	0,850	0,3790	20.700	-65	200	42,2	MS17985C608 / NAS1336A2C08D	4211.D08
3/8	0,3720	0,3735	1,0	0,440 in	0,365	0,390	0,625	2,065	1,45	0,850	0,3790	20.700	-65	200	44,9	MS17985C610 / NAS1336A2C10D	4211.D10
3/8	0,3720	0,3735	1,1	0,440 in	0,365	0,390	0,625	2,065	1,45	0,850	0,3790	20.700	-65	200	46,3	MS17985C611 / NAS1336A2C11D	4211.D11
3/8	0,3720	0,3735	1,2	0,440 in	0,365	0,390	0,625	2,065	1,45	0,850	0,3790	20.700	-65	200	47,6	MS17985C612 / NAS1336A2C12D	4211.D12
3/8	0,3720	0,3735	1,3	0,440 in	0,365	0,390	0,625	2,065	1,45	0,850	0,3790	20.700	-65	200	49,0	MS17985C613 / NAS1336A2C13D	4211.D13
3/8	0,3720	0,3735	1,4	0,440 in	0,365	0,390	0,625	2,065	1,45	0,850	0,3790	20.700	-65	200	50,3	MS17985C614 / NAS1336A2C14D	4211.D14
3/8	0,3720	0,3735	1,5	0,440 in	0,365	0,390	0,625	2,065	1,45	0,850	0,3790	20.700	-65	200	51,7	MS17985C615 / NAS1336A2C15D	4211.D15
3/8	0,3720	0,3735	1,6	0,440 in	0,365	0,390	0,625	2,065	1,45	0,850	0,3790	20.700	-65	200	53,1	MS17985C616 / NAS1336A2C16D	4211.D16
3/8	0,3720	0,3735	1,7	0,440 in	0,365	0,390	0,625	2,065	1,45	0,850	0,3790	20.700	-65	200	54,4	MS17985C617 / NAS1336A2C17D	4211.D17
3/8	0,3720	0,3735	1,8	0,440 in	0,365	0,390	0,625	2,065	1,45	0,850	0,3790	20.700	-65	200	55,8	MS17985C618 / NAS1336A2C18D	4211.D18
3/8	0,3720	0,3735	1,9	0,440 in	0,365	0,390	0,625	2,065	1,45	0,850	0,3790	20.700	-65	200	57,1	MS17985C619 / NAS1336A2C19D	4211.D19
3/8	0,3720	0,3735	2,0	0,440 in	0,365	0,390	0,625	2,065	1,45	0,850	0,3790	20.700	-65	200	58,5	MS17985C620 / NAS1336A2C20D	4211.D20
3/8	0,3720	0,3735	2,1	0,440 in	0,365	0,390	0,625	2,065	1,45	0,850	0,3790	20.700	-65	200	59,9	MS17985C621 / NAS1336A2C21D	4211.D21
3/8	0,3720	0,3735	2,2	0,440 in	0,365	0,390	0,625	2,065	1,45	0,850	0,3790	20.700	-65	200	61,2	MS17985C622 / NAS1336A2C22D	4211.D22
3/8	0,3720	0,3735	2,4	0,440 in	0,365	0,390	0,625	2,065	1,45	0,850	0,3790	20.700	-65	200	63,9	MS17985C624 / NAS1336A2C24D	4211.D24
3/8	0,3720	0,3735	2,5	0,440 in	0,365	0,390	0,625	2,065	1,45	0,850	0,3790	20.700	-65	200	65,3	MS17985C625 / NAS1336A2C25D	4211.D25
3/8	0,3720	0,3735	2,6	0,440 in	0,365	0,390	0,625	2,065	1,45	0,850	0,3790	20.700	-65	200	66,7	MS17985C626 / NAS1336A2C26D	4211.D26
3/8	0,3720	0,3735	2,8	0,440 in	0,365	0,390	0,625	2,065	1,45	0,850	0,3790	20.700	-65	200	69,4	MS17985C628 / NAS1336A2C28D	4211.D28
3/8	0,3720	0,3735	3,0	0,440 in	0,365	0,390	0,625	2,065	1,45	0,850	0,3790	20.700	-65	200	72,1	MS17985C630 / NAS1336A2C30D	4211.D30
3/8	0,3720	0,3735	3,1	0,440 in	0,365	0,390	0,625	2,065	1,45	0,850	0,3790	20.700	-65	200	73,5	MS17985C631 / NAS1336A2C31D	4211.D31
3/8	0,3720	0,3735	3,2	0,440 in	0,365	0,390	0,625	2,065	1,45	0,850	0,3790	20.700	-65	200	74,8	MS17985C632 / NAS1336A2C32D	4211.D32
3/8	0,3720	0,3735	3,4	0,440 in	0,365	0,390	0,625	2,065	1,45	0,850	0,3790	20.700	-65	200	77,5	MS17985C634 / NAS1336A2C34D	4211.D34
3/8	0,3720	0,3735	3,5	0,440 in	0,365	0,390	0,625	2,065	1,45	0,850	0,3790	20.700	-65	200	78,9	MS17985C635 / NAS1336A2C35D	4211.D35
3/8	0,3720	0,3735	4,0	0,440 in	0,365	0,390	0,625	2,065	1,45	0,850	0,3790	20.700	-65	200	85,7	MS17985C640 / NAS1336A2C40D	4211.D40
3/8	0,3720	0,3735	4,5	0,440 in	0,365	0,390	0,625	2,065	1,45	0,850	0,3790	20.700	-65	200	92,5	MS17985C645 / NAS1336A2C45D	4211.D45
3/8	0,3720	0,3735	4,8	0,440 in	0,365	0,390	0,625	2,065	1,45	0,850	0,3790	20.700	-65	200	96,6	MS17985C648 / NAS1336A2C48D	4211.D48



Nenn- durch- messer A	A min.	A max.	Klemm- länge L +0,02 0	Abmessungen							Aufnahme- bohrung max.	Scherfestigkeit zweischneittig min.	🌡️		🏋️	Norm- bezeichnung	Art.-Nr.
				B ±0,005	C 0 -0,04	D max.	E max.	F max.	G max.	H min.			min.	max.			
[in]	[in]	[in]	[in]			[in]					[in]	[lbf]	[°F]	[g]			
3/8	0,3720	0,3735	5,0	0,440 in	0,365	0,390	0,625	2,065	1,45	0,850	0,3790	20.700	-65	200	99,3	MS17985C650 / NAS1336A2C50D	4211.D50
3/8	0,3720	0,3735	5,5	0,440 in	0,365	0,390	0,625	2,065	1,45	0,850	0,3790	20.700	-65	200	106,0	MS17985C655 / NAS1336A2C55D	4211.D55
3/8	0,3720	0,3735	6,0	0,440 in	0,365	0,390	0,625	2,065	1,45	0,850	0,3790	20.700	-65	200	113,0	MS17985C660 / NAS1336A2C60D	4211.D60
7/16	0,4345	0,4360	0,8	0,509 in	0,380	0,390	0,625	2,065	1,47	0,850	0,4425	28.500	-65	200	48,1	MS17985C708 / NAS1337A2C08D	4211.E08
7/16	0,4345	0,4360	1,0	0,509 in	0,380	0,390	0,625	2,065	1,47	0,850	0,4425	28.500	-65	200	51,8	MS17985C710 / NAS1337A2C10D	4211.E10
7/16	0,4345	0,4360	1,1	0,509 in	0,380	0,390	0,625	2,065	1,47	0,850	0,4425	28.500	-65	200	53,6	MS17985C711 / NAS1337A2C11D	4211.E11
7/16	0,4345	0,4360	1,2	0,509 in	0,380	0,390	0,625	2,065	1,47	0,850	0,4425	28.500	-65	200	55,5	MS17985C712 / NAS1337A2C12D	4211.E12
7/16	0,4345	0,4360	1,5	0,509 in	0,380	0,390	0,625	2,065	1,47	0,850	0,4425	28.500	-65	200	61,1	MS17985C715 / NAS1337A2C15D	4211.E15
7/16	0,4345	0,4360	1,8	0,509 in	0,380	0,390	0,625	2,065	1,47	0,850	0,4425	28.500	-65	200	66,7	MS17985C718 / NAS1337A2C18D	4211.E18
7/16	0,4345	0,4360	2,0	0,509 in	0,380	0,390	0,625	2,065	1,47	0,850	0,4425	28.500	-65	200	70,4	MS17985C720 / NAS1337A2C20D	4211.E20
7/16	0,4345	0,4360	2,1	0,509 in	0,380	0,390	0,625	2,065	1,47	0,850	0,4425	28.500	-65	200	72,2	MS17985C721 / NAS1337A2C21D	4211.E21
7/16	0,4345	0,4360	2,3	0,509 in	0,380	0,390	0,625	2,065	1,47	0,850	0,4425	28.500	-65	200	75,9	MS17985C723 / NAS1337A2C23D	4211.E23
7/16	0,4345	0,4360	2,4	0,509 in	0,380	0,390	0,625	2,065	1,47	0,850	0,4425	28.500	-65	200	77,8	MS17985C724 / NAS1337A2C24D	4211.E24
7/16	0,4345	0,4360	2,5	0,509 in	0,380	0,390	0,625	2,065	1,47	0,850	0,4425	28.500	-65	200	79,6	MS17985C725 / NAS1337A2C25D	4211.E25
7/16	0,4345	0,4360	2,6	0,509 in	0,380	0,390	0,625	2,065	1,47	0,850	0,4425	28.500	-65	200	81,5	MS17985C726 / NAS1337A2C26D	4211.E26
7/16	0,4345	0,4360	2,8	0,509 in	0,380	0,390	0,625	2,065	1,47	0,850	0,4425	28.500	-65	200	85,2	MS17985C728 / NAS1337A2C28D	4211.E28
7/16	0,4345	0,4360	2,9	0,509 in	0,380	0,390	0,625	2,065	1,47	0,850	0,4425	28.500	-65	200	87,1	MS17985C729 / NAS1337A2C29D	4211.E29
7/16	0,4345	0,4360	3,0	0,509 in	0,380	0,390	0,625	2,065	1,47	0,850	0,4425	28.500	-65	200	88,9	MS17985C730 / NAS1337A2C30D	4211.E30
7/16	0,4345	0,4360	3,1	0,509 in	0,380	0,390	0,625	2,065	1,47	0,850	0,4425	28.500	-65	200	90,8	MS17985C731 / NAS1337A2C31D	4211.E31
7/16	0,4345	0,4360	3,2	0,509 in	0,380	0,390	0,625	2,065	1,47	0,850	0,4425	28.500	-65	200	92,6	MS17985C732 / NAS1337A2C32D	4211.E32
7/16	0,4345	0,4360	3,6	0,509 in	0,380	0,390	0,625	2,065	1,47	0,850	0,4425	28.500	-65	200	100,0	MS17985C736 / NAS1337A2C36D	4211.E36
7/16	0,4345	0,4360	4,0	0,509 in	0,380	0,390	0,625	2,065	1,47	0,850	0,4425	28.500	-65	200	107,0	MS17985C740 / NAS1337A2C40D	4211.E40
7/16	0,4345	0,4360	4,2	0,509 in	0,380	0,390	0,625	2,065	1,47	0,850	0,4425	28.500	-65	200	111,0	MS17985C742 / NAS1337A2C42D	4211.E42
7/16	0,4345	0,4360	4,6	0,509 in	0,380	0,390	0,625	2,065	1,47	0,850	0,4425	28.500	-65	200	119,0	MS17985C746 / NAS1337A2C46D	4211.E46
7/16	0,4345	0,4360	5,0	0,509 in	0,380	0,390	0,625	2,065	1,47	0,850	0,4425	28.500	-65	200	126,0	MS17985C750 / NAS1337A2C50D	4211.E50
7/16	0,4345	0,4360	5,3	0,509 in	0,380	0,390	0,625	2,065	1,47	0,850	0,4425	28.500	-65	200	132,0	MS17985C753 / NAS1337A2C53D	4211.E53
7/16	0,4345	0,4360	5,5	0,509 in	0,380	0,390	0,625	2,065	1,47	0,850	0,4425	28.500	-65	200	135,0	MS17985C755 / NAS1337A2C55D	4211.E55
7/16	0,4345	0,4360	5,6	0,509 in	0,380	0,390	0,625	2,065	1,47	0,850	0,4425	28.500	-65	200	137,0	MS17985C756 / NAS1337A2C56D	4211.E56
7/16	0,4345	0,4360	7,2	0,509 in	0,380	0,390	0,625	2,065	1,60	0,850	0,4425	28.500	-65	200	167,0	MS17985C772 / NAS1337A2C72D	4211.E72
1/2	0,4970	0,4985	0,8	0,594 in	0,460	0,565	0,800	2,345	1,60	0,885	0,5050	36.900	-65	200	69,6	MS17985C808 / NAS1338A2C08D	4211.F08
1/2	0,4970	0,4985	0,9	0,594 in	0,460	0,565	0,800	2,345	1,60	0,885	0,5050	36.900	-65	200	72,1	MS17985C809 / NAS1338A2C09D	4211.F09
1/2	0,4970	0,4985	1,0	0,594 in	0,460	0,565	0,800	2,345	1,60	0,885	0,5050	36.900	-65	200	74,4	MS17985C810 / NAS1338A2C10D	4211.F10

Nenn- durch- messer A	A min.	A max.	Klemm- länge L +0,02 0	Abmessungen							Aufnahme- bohrung max.	Scherfestigkeit zweischrittig min.	 min. max.		 [g]	Norm- bezeichnung	Art.-Nr.
				B ±0,005	C 0 -0,04	D max.	E max.	F max.	G max.	H min.			[in]	[lbF]			
[in]	[in]	[in]	[in]	[in]							[in]	[lbF]	[°F]	[g]			
1/2	0,4970	0,4985	1,1	0,594 in	0,460	0,565	0,800	2,345	1,60	0,885	0,5050	36.900	-65	200	76,9	MS17985C811 / NAS1338A2C11D	4211.F11
1/2	0,4970	0,4985	1,2	0,594 in	0,460	0,565	0,800	2,345	1,60	0,885	0,5050	36.900	-65	200	79,3	MS17985C812 / NAS1338A2C12D	4211.F12
1/2	0,4970	0,4985	1,3	0,594 in	0,460	0,565	0,800	2,345	1,60	0,885	0,5050	36.900	-65	200	81,8	MS17985C813 / NAS1338A2C13D	4211.F13
1/2	0,4970	0,4985	1,4	0,594 in	0,460	0,565	0,800	2,345	1,60	0,885	0,5050	36.900	-65	200	84,2	MS17985C814 / NAS1338A2C14D	4211.F14
1/2	0,4970	0,4985	1,5	0,594 in	0,460	0,565	0,800	2,345	1,60	0,885	0,5050	36.900	-65	200	86,6	MS17985C815 / NAS1338A2C15D	4211.F15
1/2	0,4970	0,4985	1,6	0,594 in	0,460	0,565	0,800	2,345	1,60	0,885	0,5050	36.900	-65	200	89,1	MS17985C816 / NAS1338A2C16D	4211.F16
1/2	0,4970	0,4985	1,7	0,594 in	0,460	0,565	0,800	2,345	1,60	0,885	0,5050	36.900	-65	200	91,5	MS17985C817 / NAS1338A2C17D	4211.F17
1/2	0,4970	0,4985	1,8	0,594 in	0,460	0,565	0,800	2,345	1,60	0,885	0,5050	36.900	-65	200	94,0	MS17985C818 / NAS1338A2C18D	4211.F18
1/2	0,4970	0,4985	1,9	0,594 in	0,460	0,565	0,800	2,345	1,60	0,885	0,5050	36.900	-65	200	96,4	MS17985C819 / NAS1338A2C19D	4211.F19
1/2	0,4970	0,4985	2,0	0,594 in	0,460	0,565	0,800	2,345	1,60	0,885	0,5050	36.900	-65	200	98,8	MS17985C820 / NAS1338A2C20D	4211.F20
1/2	0,4970	0,4985	2,1	0,594 in	0,460	0,565	0,800	2,345	1,60	0,885	0,5050	36.900	-65	200	101,0	MS17985C821 / NAS1338A2C21D	4211.F21
1/2	0,4970	0,4985	2,2	0,594 in	0,460	0,565	0,800	2,345	1,60	0,885	0,5050	36.900	-65	200	104,0	MS17985C822 / NAS1338A2C22D	4211.F22
1/2	0,4970	0,4985	2,3	0,594 in	0,460	0,565	0,800	2,345	1,60	0,885	0,5050	36.900	-65	200	106,0	MS17985C823 / NAS1338A2C23D	4211.F23
1/2	0,4970	0,4985	2,4	0,594 in	0,460	0,565	0,800	2,345	1,60	0,885	0,5050	36.900	-65	200	109,0	MS17985C824 / NAS1338A2C24D	4211.F24
1/2	0,4970	0,4985	2,5	0,594 in	0,460	0,565	0,800	2,345	1,60	0,885	0,5050	36.900	-65	200	111,0	MS17985C825 / NAS1338A2C25D	4211.F25
1/2	0,4970	0,4985	2,6	0,594 in	0,460	0,565	0,800	2,345	1,60	0,885	0,5050	36.900	-65	200	114,0	MS17985C826 / NAS1338A2C26D	4211.F26
1/2	0,4970	0,4985	2,8	0,594 in	0,460	0,565	0,800	2,345	1,60	0,885	0,5050	36.900	-65	200	118,0	MS17985C828 / NAS1338A2C28D	4211.F28
1/2	0,4970	0,4985	2,9	0,594 in	0,460	0,565	0,800	2,345	1,60	0,885	0,5050	36.900	-65	200	121,0	MS17985C829 / NAS1338A2C29D	4211.F29
1/2	0,4970	0,4985	3,1	0,594 in	0,460	0,565	0,800	2,345	1,60	0,885	0,5050	36.900	-65	200	126,0	MS17985C831 / NAS1338A2C31D	4211.F31
1/2	0,4970	0,4985	3,2	0,594 in	0,460	0,565	0,800	2,345	1,60	0,885	0,5050	36.900	-65	200	128,0	MS17985C832 / NAS1338A2C32D	4211.F32
1/2	0,4970	0,4985	3,3	0,594 in	0,460	0,565	0,800	2,345	1,60	0,885	0,5050	36.900	-65	200	138,0	MS17985C833 / NAS1338A2C33D	4211.F33
1/2	0,4970	0,4985	3,4	0,594 in	0,460	0,565	0,800	2,345	1,60	0,885	0,5050	36.900	-65	200	133,0	MS17985C834 / NAS1338A2C34D	4211.F34
1/2	0,4970	0,4985	3,5	0,594 in	0,460	0,565	0,800	2,345	1,60	0,885	0,5050	36.900	-65	200	135,0	MS17985C835 / NAS1338A2C35D	4211.F35
1/2	0,4970	0,4985	3,6	0,594 in	0,460	0,565	0,800	2,345	1,60	0,885	0,5050	36.900	-65	200	138,0	MS17985C836 / NAS1338A2C36D	4211.F36
1/2	0,4970	0,4985	3,7	0,594 in	0,460	0,565	0,800	2,345	1,60	0,885	0,5050	36.900	-65	200	140,0	MS17985C837 / NAS1338A2C37D	4211.F37
1/2	0,4970	0,4985	4,0	0,594 in	0,460	0,565	0,800	2,345	1,60	0,885	0,5050	36.900	-65	200	148,0	MS17985C840 / NAS1338A2C40D	4211.F40
1/2	0,4970	0,4985	4,2	0,594 in	0,460	0,565	0,800	2,345	1,60	0,885	0,5050	36.900	-65	200	153,0	MS17985C842 / NAS1338A2C42D	4211.F42
1/2	0,4970	0,4985	4,3	0,594 in	0,460	0,565	0,800	2,345	1,60	0,885	0,5050	36.900	-65	200	155,0	MS17985C843 / NAS1338A2C43D	4211.F43
1/2	0,4970	0,4985	4,4	0,594 in	0,460	0,565	0,800	2,345	1,60	0,885	0,5050	36.900	-65	200	157,0	MS17985C844 / NAS1338A2C44D	4211.F44
1/2	0,4970	0,4985	4,5	0,594 in	0,460	0,565	0,800	2,345	1,60	0,885	0,5050	36.900	-65	200	160,0	MS17985C845 / NAS1338A2C45D	4211.F45
1/2	0,4970	0,4985	4,7	0,594 in	0,460	0,565	0,800	2,345	1,60	0,885	0,5050	36.900	-65	200	165,0	MS17985C847 / NAS1338A2C47D	4211.F47
1/2	0,4970	0,4985	4,8	0,594 in	0,460	0,565	0,800	2,345	1,60	0,885	0,5050	36.900	-65	200	167,0	MS17985C848 / NAS1338A2C48D	4211.F48

Nenn- durch- messer A	A min.	A max.	Klemm- länge L +0,02 0	Abmessungen							Aufnahme- bohrung max.	Scherfestigkeit zweischrittig min.	Temperatur		Norm- bezeichnung	Art.-Nr.	
				B ±0,005	C 0 -0,04	D max.	E max.	F max.	G max.	H min.			min.	max.			
[in]	[in]	[in]	[in]	[in]							[in]	[lbf]	[°F]	[g]			
1/2	0,4970	0,4985	5,0	0,594 in	0,460	0,565	0,800	2,345	1,60	0,885	0,5050	36.900	-65	200	172,0	MS17985C850 / NAS1338A2C50D	4211.F50
1/2	0,4970	0,4985	5,5	0,594 in	0,460	0,565	0,800	2,345	1,60	0,885	0,5050	36.900	-65	200	184,0	MS17985C855 / NAS1338A2C55D	4211.F55
1/2	0,4970	0,4985	6,4	0,594 in	0,460	0,565	0,800	2,345	1,60	0,885	0,5050	36.900	-65	200	206,0	MS17985C864 / NAS1338A2C64D	4211.F64
1/2	0,4970	0,4985	8,0	0,594 in	0,460	0,565	0,800	2,345	1,60	0,885	0,5050	36.900	-65	200	245,0	MS17985C880 / NAS1338A2C80D	4211.F80
1/2	0,4970	0,4985	9,0	0,594 in	0,460	0,565	0,800	2,345	1,60	0,885	0,5050	36.900	-65	200	270,0	MS17985C890 / NAS1338A2C90D	4211.F90
9/16	0,5595	0,5610	1,0	0,666 in	0,510	0,565	0,800	2,345	1,60	0,885	0,5675	46.700	-65	200	84,9	MS17985C910 / NAS1339A2C10D	4211.G10
9/16	0,5595	0,5610	1,2	0,666 in	0,510	0,565	0,800	2,345	1,60	0,885	0,5675	46.700	-65	200	91,2	MS17985C912 / NAS1339A2C12D	4211.G12
9/16	0,5595	0,5610	1,7	0,666 in	0,510	0,565	0,800	2,345	1,60	0,885	0,5675	46.700	-65	200	107,0	MS17985C917 / NAS1339A2C17D	4211.G17
9/16	0,5595	0,5610	2,4	0,666 in	0,510	0,565	0,800	2,345	1,60	0,885	0,5675	46.700	-65	200	128,0	MS17985C924 / NAS1339A2C24D	4211.G24
9/16	0,5595	0,5610	2,5	0,666 in	0,510	0,565	0,800	2,345	1,60	0,885	0,5675	46.700	-65	200	132,0	MS17985C925 / NAS1339A2C25D	4211.G25
9/16	0,5595	0,5610	3,2	0,666 in	0,510	0,565	0,800	2,345	1,60	0,885	0,5675	46.700	-65	200	153,0	MS17985C932 / NAS1339A2C32D	4211.G32
9/16	0,5595	0,5610	3,6	0,666 in	0,510	0,565	0,800	2,345	1,60	0,885	0,5675	46.700	-65	200	166,0	MS17985C936 / NAS1339A2C36D	4211.G36
9/16	0,5595	0,5610	4,0	0,666 in	0,510	0,565	0,800	2,345	1,60	0,885	0,5675	46.700	-65	200	178,0	MS17985C940 / NAS1339A2C40D	4211.G40
9/16	0,5595	0,5610	5,0	0,666 in	0,510	0,565	0,800	2,345	1,60	0,885	0,5675	46.700	-65	200	209,0	MS17985C950 / NAS1339A2C50D	4211.G50
9/16	0,5595	0,5610	5,5	0,666 in	0,510	0,565	0,800	2,345	1,60	0,885	0,5675	46.700	-65	200	225,0	MS17985C955 / NAS1339A2C55D	4211.G55
9/16	0,5595	0,5610	6,1	0,666 in	0,510	0,565	0,800	2,345	1,60	0,885	0,5675	46.700	-65	200	244,0	MS17985C961 / NAS1339A2C61D	4211.G61
5/8	0,6220	0,6240	1,5	0,750 in	0,580	0,580	0,975	3,100	1,70	0,980	0,6300	57.800	-65	200	151,0	MS17985C1015 / NAS1340A2C15D	4211.H15
5/8	0,6220	0,6240	4,0	0,750 in	0,580	0,580	0,975	3,100	1,70	0,980	0,6300	57.800	-65	200	247,0	MS17985C1040 / NAS1340A2C40D	4211.H40
5/8	0,6220	0,6240	4,5	0,750 mm	0,580	0,580	0,975	3,100	1,70	0,980	0,6300	57.800	-65	200	267,0	MS17985C1045 / NAS1340A2C45D	4211.H45
5/8	0,6220	0,6240	6,0	0,750 mm	0,580	0,580	0,975	3,100	1,70	0,980	0,6300	57.800	-65	200	324,0	MS17985C1060 / NAS1340A2C60D	4211.H60
3/4	0,7470	0,7485	1,6	0,887 mm	0,670	0,700	1,000	3,100	1,72	1,030	0,7570	83.200	-65	200	198,0	MS17985C1216 / NAS1341A2C16D	4211.K16
3/4	0,7470	0,7485	4,0	0,887 mm	0,670	0,700	1,000	3,100	1,72	1,030	0,7570	83.200	-65	200	331,0	MS17985C1240 / NAS1341A2C40D	4211.K40
3/4	0,7470	0,7485	8,0	0,887 mm	0,670	0,700	1,000	3,100	1,72	1,030	0,7570	83.200	-65	200	553,0	MS17985C1280 / NAS1341A2C80D	4211.K80
7/8	0,8720	0,8735	4,0	1,046 in	0,760	0,840	1,320	3,520	2,17	1,310	0,8820	112.500	-65	200	506,0	MS17985C1440 / NAS1342A2C40D	4211.L40
1	0,9970	0,9985	1,5	1,219 in	0,810	0,950	1,320	3,520	2,17	1,310	1,0100	147.200	-65	200	383,0	MS17985C1615 / NAS1343A2C15D	4211.M15
1	0,9970	0,9985	4,0	1,219 in	0,810	0,950	1,320	3,520	2,17	1,310	1,0100	147.200	-65	200	631,0	MS17985C1640 / NAS1343A2C40D	4211.M40

## Compliance

Für detaillierte Compliance Informationen wählen Sie bitte die gewünschte Artikelnummer.